

www.italiastar.ro



Listă de prețuri 2024 DISTRIBUȚIE

Utilaje și echipamente
pentru construcții



Valabil începând cu:
26.11.2024

Cuprins

IMER & MARUZEN



Betoniere profesionale
Pagina 05



Betoniere semi-automate
Pagina 06



Pompa multifunctionala SMALL 50
Pagina 07



Electropalane
Pagina 09



Malaxoare planetare si continue
Pagina 11



Circulare pentru lemn
Pagina 12



Masini pentru taiat gresie si faianta
Pagina 13



Masina pentru taiat caramida, piatra naturala si tigla
Pagina 14



Sisteme pentru vibrare beton
Pagina 15



Elicoptere pardoseala
Pagina 16



Grup hidraulic si accesorii
Pagina 17

BISONTE CONSTRUCTII



Compactare
Pagina 19



Masini de taiat asfalt/beton
Pagina 22



Masini de taiat caramida/BCA/metale ghilotina pavele
Pagina 23



Discuri diamantate segmentate
Pagina 24



Masini de taiat gresie/faianta Ghilotina
Pagina 25



Elicoptere pentru slefuit si finisat pardoseli
Pagina 26



Sisteme vibrare beton
Pagina 27



Pompe pentru gleturi | tencuit
Pagina 28



Pompe airless zugravit | vopsit
Pagina 32



Slefuire pereti | tavan Aspiratoare si malaxoare
Pagina 37



Compressoare electrice
Pagina 39



Aparate de sudura Taiere cu plasma
Pagina 41



Scari profesionale si universale
Pagina 43



Betoniere Roabe
Pagina 45



Masini de carotat
Pagina 46



Generatoare open
Pagina 47

BISONTE AGRO



Motocultoare
Pagina 49



Masini multifunctionale
Pagina 52



Remorci pentru motocultoare
Pagina 54



Motoburghie
Pagina 54



Trenchere (sapare santuri)
Pagina 54



Motopompe si furtunuri absorbtie
Pagina 55



Masini si tractoare de tuns iarba
Pagina 57



Atomizoare
Pagina 58



Aparate de spalat cu presiune
Pagina 58



Despicatoare lemne
Pagina 59



Tocatoare crengi
Pagina 59

Cuprins

SISTEME DE POMPARE



Pompe airless cu membrana pentru zugravit
Pagina 61



Pompe airless cu membrana pentru vopsit
Pagina 63



Pompe airless cu piston pentru zugravit
Pagina 65



Pompe airless hidraulice pentru gleturi
Pagina 68



Pompe airless cu membrana pentru hidroizolatii si injectari
Pagina 69



Pompe pentru gleturi | tencuiele | decorative
Pagina 70

ECHIPAMENTE PENTRU FINISARE



Echipamente pentru finisare gips carton
Pagina 72



Echipamente pentru slefuit, raschetat, polisat
Pagina 73

SCHELE | COFRAJE | PANOURI

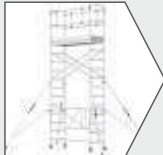

Schela mobila profesionala Protube
Pagina 77



Scari si schele profesionale
Pagina 81

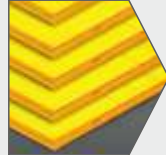

Panou galben
Pagina 84



Panou TEGO
Pagina 85



Grinda H20
Pagina 86



Accesorii pentru cofraje
Pagina 87



Accesorii pentru cofraje
Pagina 88



Popi metalici si trepiezi
Pagina 92

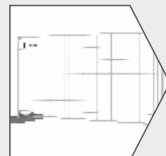

Sistem mobil EU2 Garduri
Pagina 93



Tubulatura evacuare deseuri | Parapeti rutieri
Pagina 94

GENERATOARE DE CURENT



Generatoare de curent seria Lite
Pagina 96



Generatoare de curent seria Top
Pagina 97



Generatoare de curent seria EVO
Pagina 99



Generatoare tip inverter - COVER
Pagina 100



Generatoare tip inverter - OPEN
Pagina 100



Generatoare pentru sudura
Pagina 101



Generatoare de curent rezidentiale
Pagina 102



Generatoare de curent rezidentiale
Pagina 103



Motopompe
Pagina 104



Pompe submersibile electrice
Pagina 105



Motopompe ape curate/murdare
Pagina 106



Aparataj electric
Pagina 108

ECHIPAMENTE PENTRU TAIERE GRESIE | FAIANTA



Masini manuale de taiat gresie | faianta
Pagina 111



Masini electrice de taiat gresie | faianta
Pagina 113



Echipamente diverse pentru taiere/finisare si ventuze ridicare
Pagina 114

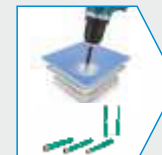

Freze, carote si accesorii
Pagina 115



Discuri diamantate
Pagina 116

IMER & MARUZEN



Betoniere profesionale
Pagina 05



Betoniere semi-automate
Pagina 06



Pompa multifunctionala SMALL 50
Pagina 07



Electropalane
Pagina 09



Malaxoare planetare si continue
Pagina 11



Circulare pentru lemn
Pagina 12



Masini pentru taiat gresie si faianta
Pagina 13



Masina pentru taiat caramida, piatra naturala si tigla
Pagina 14



Sisteme pentru vibrare beton
Pagina 15



Elicoptere pardoseala
Pagina 16



Grup hidraulic si accesorii
Pagina 17



Cod produs	Descriere produs	Pret Euro (fara TVA)
Minibeta		
8033679000332	Minibeta 130 motor monofazat 2P 230V 50 Hz 0,3 kW	578
8033679000349	Minibeta 130 2P motor monofazat 0,3 kW - cuva plastic HDPE	699
Rollbeta		
8033679000103	Rollbeta 130 motor monofazat 2P 230V 50 Hz 0,3 kW	647
8033679003012	Rollbeta 130 motor monofazat 2P 230V 50 Hz 0,37 kW - cuva plastic HDPE	717
8033679000110	Rollbeta 130 cu motor benzina	1.342
IM1105490	Suport rotativ	199
IM1188810	Bena plastic HDPE pentru Rollbeta/Syntesi 140	261
8033679027902	Riobeta 130 motor monofazat 230V - 0,3 kW	672
Syntesi		
8033679000141	Syntesi 140 motor monofazat 230V 50 Hz 0,3 kW	767
8033679000158	Syntesi 140 motor monofazat 230V 50 Hz 0,3 kW cuva plastic HDPE	892
8033679017903	Syntesi 160 cu motor monofazat 230V-50Hz 0,3 kW	836
8033679000165	Syntesi 190 cu motor monofazat 230V-50Hz 1 kW	1.164
8033679000202	Syntesi 250 cu motor monofazat 230V-50Hz 1 kW	1.345
8033679000219	Syntesi 250 cu motor benzina Worms EX170, 5,6 cp	2.541
8033679002701	Syntesi 300 cu motor monofazat 230V-50Hz 1,4 kW	1.632
8033679000264	Syntesi 350 cu motor monofazat 230V-50Hz 1,4 kW	1.560
8033679004842	Syntesi 350 cu motor benzina Honda, 5,4 cp	3.000
IM1105804	Syntesi 350 cu motor Yanmar diesel, 7,7 cp	la cerere
IM3209650	Curea distributie Syntesi 140-160	10,5
IM3208791	Curea distributie Syntesi 190-250	18,3
IM3235727	Curea distributie Syntesi 300-350	19,7
IM3209809	Roata pentru Syntesi 140 sau 160	7,1
IM2211100	Roata pentru Syntesi 190 dim. 300x60 mm	15,4
IM2211200	Roata pentru Syntesi 250 dim. 370x70 mm	25,0
IM2211250	Roata pentru Syntesi 300 sau 350 dim. 385x90 mm	30,7
3161304182384	Clean Syntesi Acid mineral destinat curatarii betonierelor interior/exterior 0,5L	10,8
3161304182377	Clean Syntesi Acid mineral destinat curatarii betonierelor interior/exterior 1L	21,5
Syntesi R - remorcabile in santier (neomologabile rutier)		
8033679000189	Syntesi 190 R cu motor monofazat 240V-50Hz, 1 kW	1.447
8033679000196	Syntesi 190R cu motor benzina Honda, 3,9 cp	2.238
8033679020408	Syntesi 250 R omologabil cu motor monofazat 230V-50Hz 1 kW	2.297
8033679020422	Syntesi 250 R omologabil cu motor benzina Honda 3,9 cp	3.502
8033679020446	Syntesi 350 R omologabil cu motor monofazat 230V-50Hz 1,4 kW	2.561
8033679020460	Syntesi 350 R omologabil cu motor benzina Honda 5,4 cp	3.601
IM1105831	Syntesi 350 R omologabil cu motor diesel Yanmar 5,4 cp	la cerere



Cod produs	Descriere produs	Pret Euro (fara TVA)
SI1007651	BIR 330 / ID motor electric 3 kW, capacitate cuva brut 330 l productivitate 6,5 m ³ /h, greutate echipament 900 kg	8.108
SI1007652	BIR 330 / ID Kohler diesel 7,5 cp, demaraj electric, capacitate cuva brut 300 l, productivitate 6,5 m ³ /h, greutate 900 kg	la cerere
SI1007067	BIR 400 / ID electric 3 kW, capacitate cuva brut 400 l productivitate 8m ³ /h, greutate echipament 950 kg	8.433
SI1007653	BIR 400 / ID Hatz diesel A/E 9,5 cp, demaraj electric capacitate cuva brut 400 l, productivitate 8m ³ /h, greutate 950 kg	la cerere
SI1007654	BIR 500 / ID electric 4,1 kW, capacitate cuva brut 500 l productivitate 12 m ³ /h, greutate echipament 1.540 kg	11.490
SI1007655	BIR 500 / ID Kohler diesel A/E 28,5 cp, demaraj electric, capacitate cuva brut 500 l, productivitate 12m ³ /h greutate 1.540 kg	la cerere
SI1007137	BIR 750 / ID electric 5,6 kW, capacitate cuva brut 750 l, productivitate 17 m ³ /h, greutate echipament 1.700 kg	14.386
SI1007656	BIR 750 / ID Kohler diesel A/E 28,5 cp, demaraj electric, capacitate cuva brut 750 l, productivitate 17 m ³ /h greutate 1.700 kg	la cerere
SI1006522	BIR 1000 / ID electric 7,5 kW, capacitate cuva brut 1.000 l, productivitate 18 m ³ /h, greutate echipament 1.800 kg	16.428
SI1007657	BIR 1000 / ID Hatz diesel A/E 34,5 cp, demaraj electric, capacitate cuva brut 1.000 l, productivitate 18 m ³ /h, greutate 1.800 kg	la cerere
SI1007658	BIR 1500 / ID electric 15 kW, capacitate cuva brut 1.500 l, productivitate 22 m ³ /h, greutate echipament 2.400 kg	23.444
SI1007659	BIR 1500 / ID Hatz diesel A/E 34,5 cp, demaraj electric capacitate cuva brut 1.500 l, productivitate 22 m ³ /h, greutate 2.600 kg	la cerere
Accesorii		
BIRLTE	Lopata tarsietoare pentru incarcare paleta pentru betoniere motor termic	2.197
BIRLTT	Lopata tarsietoare pentru incarcare paleta pentru betoniere motor electric	1.704
BIRCLIT	Contor apa	863
BIRBILIT	Cantar electronic	2.060
BIR4WIT	Sistem cu 4 roti, doar pentru BIR 500/700/1.000	811
VIBRIT	Vibrator	763



Cod produs	Descriere produs	Pret Euro (fara TVA)
------------	------------------	----------------------

8033679032715	Small 50 EVO pompa cu snec, versiune standard fara accesorii	4.534
---------------	---	-------

Debit material 0,8-14 l/min., granulometrie max. 6 mm,
 Echipament multifunctional care se utilizeaza cu unul din urmatoarele kit-uri:

Kit pentru tencuiala traditionala sau preamestecata

8033679002220	Sita vibranta 230V 50 Hz	834
---------------	--------------------------	-----

8033679002213	Compresor cu membrana 230V 50Hz	1.499
---------------	---------------------------------	-------

IM1107005	Kit compus din:	495
-----------	-----------------	-----

Lance aplicare mortare traditionale sau preamestec
 15 m furtun pentru material Ø 25 mm cuplari rapide
 16 m furtun aer Ø 13 mm cu cuplari Geka
 Lance curatire si burete Ø 30 mm
 Deflector Ø 10 - 14 mm pentru mortar preamestec
 Deflector Ø 12 mm pentru mortar traditional



Kit pentru gleturi

8033679002213	Compresor cu membrana 230V 50Hz	1.499
---------------	---------------------------------	-------

IM1107005	Kit compus din:	495
-----------	-----------------	-----

Lance aplicare mortare traditionale sau preamestec
 15 m furtun pentru material Ø 25 mm cuplari rapide
 16 m furtun aer Ø 13 mm cu cuplari Geka
 Lance curatire si burete Ø 30 mm
 Deflector Ø 10 - 14 mm pentru mortar preamestec
 Deflector Ø 12 mm pentru mortar traditional



1107543
 Compresor
 cu membrana

Kit pentru injectare mortare

8033679002220	Sita vibranta 230V 50 Hz	834
---------------	--------------------------	-----

IM1108005	Kit compus din:	1.509
-----------	-----------------	-------

Lance pentru injectare, chituire rosturi, vopsire
 Manometru si comutator de presiune
 5+10 m furtun pentru material Ø 25 mm cuplari rapide
 Lance curatire si burete Ø 30 mm
 Deflector cu conector furtun Ø 16 mm



8033679002220
 Sita vibranta

Kit pentru zugraveli decorative

8033679002220	Sita vibranta 230V 50 Hz	834
---------------	--------------------------	-----

8033679024314	Compresor cu piston 230V 50Hz	1.760
---------------	-------------------------------	-------

IM1107009	Kit compus din:	682
-----------	-----------------	-----

Lance pentru vopsire cu deflector Ø 5 - Ø 6 mm
 Reductie pentru furtun de la Ø 25 la Ø 19
 10 m furtun material Ø 19 mm cuplari rapide
 16 m furtun aer Ø 13 mm cu cuplari Geka
 Lance curatire si burete Ø 23 mm



Kit pentru chituire rosturi

IM1107010	Kit compus din:	803
-----------	-----------------	-----

Lance pentru curatire (sablare), injectare, chituire rosturi, vopsire
 Deflector Ø 5 - Ø 6 - Ø 8 - Ø 12 mm
 Deflector cu conector furtun Ø 16 mm
 10+5 m furtun material Ø 25 mm cu cuplari rapide
 16 m furtun aer Ø 13 mm cu cuplari Geka
 Lance curatire si burete Ø 30 mm



IM1106052 **Small S50 Airless** Pompa cu snec de inalta presiune pentru aplicare airless 7.980

Debit material: 8,5 l/min.; presiune 0 - 120 bar (nu necesita compresor)
 Putere instalata 2,2 kW - 230V; amperaj 9,5 A
 Lungime pompare 30 m; capacitate bena 50 l
 Greutate echipament 70 kg; dimensiuni 1.336x504x682 mm
 Echipare standard: pistol AG19, kit duze, kit curatare pistol si duze, filtru alb si verde, 20m furtun airless 1/2"; manometru, rotor si stator 4N 13S 120bar, comanda electrica cablu 15m ; cablu electric 20m, trusa de scule integrata



IM1107540 Lance aplicare mortar preamestec cu deflector Ø 14 134

IM1107011 Lance pentru injectare, chituire rosturi, vopsire 391

IM1107549 Prelungitor lance, lungime 1,43 m 147

8033679002220 **Sita vibranta 230V / 50 Hz** 834

IM1107662 Manometru 217

IM1107515 Kit masura reglaj - control presiune, pentru injectari 527

IM1107513 Capac pentru cuva 192

8033679002213 **Compresor cu membrana 230V / 50Hz 250 l/min.** 1.499

8033679024314 Compresor cu piston 400l/min. 230V / 50Hz 1.760

IM1108009 16 m extensie la comanda electrica prin cablu 158

IM1108008 16 m comanda electrica prin cablu 135

IM1107525 15 m furtun material Ø 25 mm cu cuplari rapide 273

IM1107526 10 m furtun material Ø 25 mm cu cuplari rapide 228

IM1107527 5 m furtun material Ø 25 cu cuplari rapide 186

IM1107529 10 m furtun material Ø 19 mm cu cuplari rapide 212

IM1107530 5 m furtun aer Ø 13 mm cu cuplari Geka 30,8

IM1107531 10 m furtun aer Ø 13 mm cu cuplari Geka 49,6

IM1107532 16 m furtun aer Ø 13 mm cu cuplari Geka 65,0

IM1107570 Cuplaj tip profil "U" de otel pt furtun Ø 25 85,1

IM1107030 Stator D 8-1.5 Verde cu strangere 84,6

IM1107031 Rotor D 8-1.5 Verde 86,3

IM1107032 Stator D4 - 1/2 Verde deschis cu strangere 103

IM1107033 Rotor D4 86,3

Deflectori pentru chituire, vopsire

IM1107561 3-buc Deflectori Ø 5 mm otel 71,3

IM1107562 3-buc Deflectori Ø 6 mm otel 71,3







IM1107563 3-buc Deflectori Ø 8 mm otel 71,3

IM1107564 3-buc Deflectori Ø 12 mm otel 71,3

Deflector pentru injectare si netezire fara compresor

IM1107567 Kit cu 1 deflector + 5 conectori furtun Ø 16 mm + 5 conectori furtun Ø 13 mm 62,5



Cod produs	Descriere produs	Pret Euro (fara TVA)	
8033679019303	ES 150N cu cadru fix si morsete ancorare schela Sarcina 150 Kg - lungime cablu 30m, monofazat 230V-50Hz Comanda 3 butoane, cablu 1 m	866	
8033679002411	ET 200 N cu cadru fix, lungime cablu 30m Sarcina 200 Kg monofazat 230V-50Hz, comanda 3 butoane cablu 1 m	889	
8033679004903	ETR 200 N cu cadru extensibil, lungime cablu 30m Sarcina 200 Kg monofazat 230V-50Hz comanda 3 butoane cablu 1,5 m	956	
8033679002008	TR 225 N cu cadru extensibil, lungime cablu 30m, nu include comanda Sarcina 200 Kg - monofazat 230V-50Hz	1.051	
IM1191008	Comanda 3 butoane pe cablu la 1,5 m	143	
IM1191007	Comanda 3 butoane pe cablu la 5 m	201	
IM1191032	Comanda 3 butoane tensiune joasa 30 m	875	
8033679019310	ET 150 N cu cadru extensibil, lungime cablu 40m viteza 30 m/min. Sarcina 150 Kg monofazic 230V-50Hz comanda 3 butoane cablu 1,5 m	1.187	
8033679030605	TRVK 200 N lungime cablu 51 m, viteza de ridicare 30 m/min. Sarcina max. 200 kg, monofazic 230V-50Hz comanda cablu 1,5 m	1.284	
IM1191033	Prelungitor 50 m pentru comanda BT 24V	931	
8033679004910	AIRONE 200 N cu brat extensibil, lungime cablu 30m Sarcina 200 Kg monofazic 230V-50Hz comanda cablu 1 m	1.006	
8033679019907	AIRONE 300 NEW cu brat extensibil, lungime cablu 30m Sarcina 300 kg, monofazic 230V-50Hz, comanda 3 butoane, cabul 1,5 m	1.109	
8033679020507	ET 300N, fara suport, lungime cablu 30m Sarcina 300 Kg monofazic 230V-50Hz comanda 3 butoane, cablu 1,5 m	1.103	
8033679022501	G 500 fara suport, lungime cablu 42m Sarcina 500 Kg, monofazic 230V-50Hz, comanda 3 butoane 1,5 m	1.652	
IM1140499	Electropalan IMER AP120 Spring pentru ridicare/montare schela 120kg inaltime 40m 230V	2.160	
8033679022105	AP 150 - Electropalan pentru ridicare / montare schela Sarcina 150 kg, monofazic 230V-50 Hz, comanda 3 butoane 5 m, 81m cablu, poate ridica la 40 m inaltime, include pioner cu scripete	1.726	

Cod produs	Descriere produs	Pret Euro (fara TVA)
Suporti ancorare pentru toate electropalanele Imer, pentru ET300 si G500		
IM1191230	Suport prindere universala de max. 300Kg, fara containere contra greutate si protectia pentru picioare	921
IM1191240	Suport prindere universala de max. 500Kg, fara containere contra greutate si protectia pentru picioare	983
IM1199210	Container contragreutate 150 Kg, 1buc	288
IM1199220	Container contragreutate 250 Kg, 1buc	320
IM1199230	Lamela de protectie la partea inferioara	74,3
IM1191247	Legaturi la partea inferioara intre suportul din fata si cel din spate	51,7
IM1199215	Frana de siguranta electropalan 500kg	127
IM1199221	Container contragreutate 500 kg (1 buc.)	545
Stalpi de ancoraj pana la 200kg		
8033679001148	Stalp reglabil pe inaltime de la 2,45 la 3,3m pentru interior - se foloseste singur sau cu 1199134	380
IM1199134	Kit brate+container pentru ancorare stalp - se foloseste cu 1199102	494
IM1199105	Stalp de ancoraj pentru lateral fereastr	533
8033679001223	Suport universal electropalan cu prindere de schela	182
IM1190180	Suport electropalan cu prindere de schela pentru AP60, AP120 si Ap150	164
Stalp de ancoraj pentru AIRONE 300		
8033679001179	Stalp pentru AIRONE 300 fara container de contra greutate	642
IM1199122	Container contragreutati pentru AIRONE 300	479
Bandiere (distantiere)		
8033679001209	Bandiera pentru stalpi	181
IM1199155	Bandiera pentru morsete	101
Morsete pentru ancoraj		
8033679001162	Morsete pentru ancoraj, sarcina max. 200 Kg	80,8
Bene rabatabile pentru materiale		
8033679000677	Bena trapezoidala de 45L	200
8033679000684	Bena trapezoidala de 90L	231
	Bena trapezoidala de 120L	276
TEE001TV		
TEE001BB	Recipient dreptunghiular din PPR Teknolast cu manere, capacitate 180 l	98
	Bena basculanta polietilena 70L/150 kg	94
8033679000578	Port-galeti	
8033679000561	Port-galeti pentru 2 buc.	99,0
IM1190905	Port-galeti pentru 4 buc.	151
Ancora de ridicare materiale		
IM1191041	Suport de ridicare cu 3 carabine	138
Carucior pentru utilizare cu suport universal		
	Carucior cu frana pentru electropalane seria ES-ET-ETR	169
BA1005404		
Roaba pentru ridicare materiale cu electropalanul (brat rabatabil)		
	Capacitate 80 l, manere rabatabile	75
	Manere tubulare de 30 mm, tabla de 0,8 mm	
	Roata pneumatica 330 mm	
	Greutate 14 kg	

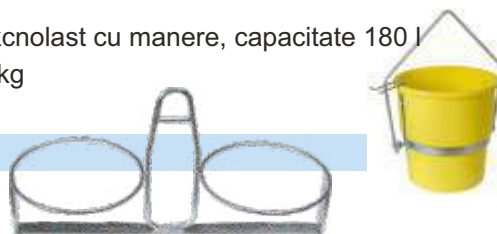

Cod produs	Descriere produs	Pret Euro (fara TVA)
8033679001025	MIX 60 cu motor monofazat 230V-50Hz putere 0,55 kW cu 2 rezervoare si paleta standard, capacitate cuva brut 56 l, diametru cuva 580 mm	765
IM1193965	Paleta pentru mixare adezivi speciali / fluide	85,3
IM1193968	Kit 5 rezervoare pentru MIX 60/MIX ALL	187
8033679029203	Mix All cu motor monofazic 230V-50Hz, putere 0,55 kW Noul tip de pale cu rotire in 3 axe Capacitate cuva 56 l, diametru cuva 580 mm Include 2 rezervoare si paleta in 3 axe	820
IM1193968	Kit 5 rezervoare pentru MIX 60/MIX ALL	187
8033679030001	Mix 80 cu motor monofazic 230V - 50 Hz, 1,1 kW Capacitate cuva brut 80 l, diametru cuva incarcare 608 mm	1.856
IM1107635	Paleta mixare din cauciuc pentru MIX 80	63,6
8033679001049	Mix 120 Plus cu motor monofazat 230V-50Hz, putere motor 1,4 kW Capacitate cuva brut 120 l, diametru cuva 745 mm	2.351
IM1107618	Kit lamele cauciuc pentru pale	71,8
Doar pentru materiale cu malaxare rapida		
Malaxor continuu SPIN		
8033679001612	Spin 15 A motor 230V - 1,4 kW debit material 15 l/min., capacitate cuva 60 l Include pompa de apa	1.950
IM1107601	Kit debitmetru apa	268
8033679035518	Spin 15 A-Z Clean Idem. Camera amestecare cu autocuratare din cauciuc elastomer.	2.070
8033679028909	Spin 30 Plus motor 400V - 3 kW debit material 30 l/min. capacitate cuva 110l	3.780
8033679028916	Spin 30 Plus motor 230V - 2,2 kW debit material 30 l/min. capacitate cuva 110l Include pompa de apa	3.830
IM1107514	Kit debitmetru apa	274



Cod produs

Descriere produs

Pret Euro
(fara TVA)

Circular pentru lemn H 110PLUS VF disc Ø350 mm Widia

Complet echipat dreptar, impingator si plan de lucru rabatabil

IM1188490 H 110VF PLUS cu motor monofazic 2,5 kW

1.010

IM1188491 H 110VF PLUS cu motor trifazic 3 kW

1.010

Circular pentru lemn H 110PLUS VR disc Ø350 mm Widia, inaltime reglabila de taiere

Complet echipat - dreptar, impingator, plan de lucru rabatabil

8033679036409 H 110VR PLUS cu motor monofazic 2,5 kW

1.027

8033679037222 H 110VR PLUS cu motor trifazic 3 kW

1.027

IM1187635 Kit roti pentru H 110

67,9

Discuri de taiat material lemnos

IM1193964 Widia Ø 300 mm x 3,2 Z = 48

97,6

IM1193960 Widia Ø 350 mm x 3,2 Z = 54

109

IM1193790 Widia Ø 315 mm x 3,2 Z = 28 (cu limitator pentru H110)

65,1

IM1193791 Widia Ø 350 mm H110 PLUS

67,8



Plan de lucru rabatabil inclus



Cod produs	Descriere produs	Pret Euro (fara TVA)
------------	------------------	----------------------

Combi 200 VA cu disc si suport

8033679000370	Masina de taiat, cu disc inclus, diam. 200 mm, motor 230V / 50 Hz 1,5 kW Lungime taiere 500 mm, adancime max. de taiere 55 mm	989
IM1188086	Plan de taiere suplimentar pentru Combi 200 VA	123
IM1193848	Disc Ø 200 mm ceramica - coroana continua	39,3
IM1193781	Disc Ø 200 mm Premium pentru gresie portelanata - coroana continua	85,3

Combi 250 VA cu disc si suport

8033679000387	Masina de taiat, cu disc inclus, diam. 250 mm, motor 230V-50Hz, 1,5 kW	1.095
IM1188166	Plan de taiere suplimentar pentru Combi 250 VA	138

Combi 250-1000 cu disc, suport si laser

8033679000400	Masina de taiat, cu disc inclus, diam. 250 mm, motor 230V-50Hz, 1,5 kW Lungime max. de taiere 1.100 mm, adancime max. taiere 105 mm	1.693
IM1188177	Plan de taiere suplimentar pentru Combi 250-1000	171
IM1188178	Dispozitiv imobilizare materiale pentru 200, 250 si 250-1000	44,2

Combi 250-1500 cu disc, suport si laser

8033679026707	Masina de taiat, cu disc inclus, diam. 250 mm, motor 1,5 kW Lungime max. taiere 1.530 mm, adancime max. taiere 105 mm	2.171
IM1188179	Plan de taiere suplimentar pentru Combi 250-1500	183

Discuri compatibile cu masinile Combi 250, 250-1000, 250-1500

BT0009525	Disc Ø=250mm, Ø interior 25,4, dim. segmente (h x grosime x L) 10x2,6x38 mm	34,3
IM1193852	Disc Ø 250 mm - ceramica - coroana continua	56,1
IM1193801	Disc Ø 250 mm caramida /tigla - coroana sectionata	75,2
IM1193804	Disc Ø 250 mm Premium pentru granit - coroana sectionata	109
IM1193783	Disc Ø 250 mm Premium pentru gresie portelanata - coroana continua	111

C350 iPower

8033679018603	Masina de taiat 230V 50 Hz, 2,5 kW cu disc inclus - diam. 350mm Lungime max. 1.200mm, adancime max. taiere 120 mm, trasator laser si roti	2.462
BT0009527	Disc Ø=350mm, Øinterior 25,4, dim. segmente (hxgrosimexL) 10x3,2x38 mm	61,8
IM1193856	Disc Ø 350 mm ceramica - coroana continua	112
IM1193785	Disc Ø 350 mm Premium pentru gresie portelanata - coroana continua	134
IM1193824	Disc Ø 350 mm Premium pentru granit - coroana sectionata	165
IM1193894	Disc Ø 350 mm caramida / tigla - coroana sectionata, laser	106
IM3233271	Pompa apa masini de taiat Imer Combi / Masonry	76,1
IM1188157	Sistem de blocare placi Combi VA – blocati plăcile și utilizați laserul masinii pentru o taiere precisă.	201



Cod produs	Descriere produs	Pret Euro (fara TVA)
M 400 SMART disc 400mm inclus		
8033679012908	M400 Smart 350/400mm, motor monofazic 2,2 kW, 230V-50Hz 2 roti pentru transport	1.552
IM1187640	Suport de taiere la 45°	107
IM1193908	Disc Ø 400 mm Premium pentru Granit / Piatra Naturala - coroana sectionata	143
IM1193824	Disc Ø 350 mm Premium Granit / piatra naturala - coroana sect. - s. laser	165
IM1193894	Disc Ø 350 mm caramida/tigla - coroana sectionata - s. laser	106
Masonry 600 (fara disc)		
8033679033903	Motor 4 kW, 400V/50Hz Diametru disc 600 mm, lungime max. taiere 750 mm (disc ridicat) Lungime max. taiere 460 mm (placi inaltime 200 mm) Adancime taiere 1 / 2 treceri: 215 / 300 mm 2 roti pentru transport	2.289
IM1193926	Disc Ø 600 mm Premium Granit / Piatra Naturala - coroana sectionata	431
Masonry 750 Plus (fara disc)		
8033679030100	Masonry 750 Plus motor 5,5 kW, 400V/50Hz	3.632
8033679030117	Masonry 750 Plus motor 2,2 kW, 230V/50Hz Diametru disc 750 mm, lungime max. taiere 560 mm Adancime max. taiere 300 mm 4 roti din care 2 directionale cu frana pentru transport	3.632
IM1193939	Disc Ø 700 mm granit / marmura / piatra naturala	621
IM1193913	Disc Ø 750 mm Premium pentru caramida / tigla	664
IM1193941	Disc Ø 750 mm Premium pentru granit / marmura / piatra naturala	721
IM1169275	Protectii laterale pentru disc	79,7
IM1188870	Suport de taiere la 45°	92,6
IM1187622	Ghidaj taiere reglabil	154
IM3233271	Pompa apa masini de taiat Imer Combi / Masonry	76,1
E001TV	Recipient dreptunghiular din PPR Teknoplant cu manere, capacitate 180 l	98



Cod produs	Descriere produs	Pret Euro (fara TVA)
------------	------------------	----------------------

IM0002000	Vibrator electric seria FX2000 , 2 kW, 230V, 12.000 rpm (nu include lance)	234
-----------	---	-----



Lance si cap vibrant pentru seria FX2000

IM0003003	Diametru Ø 30mm, 3 m lungime	168
IM0003803	Diametru Ø 38mm, 3 m lungime	174
IM0003404	Diametru Ø 34mm, 4 m lungime	186
IM0003804	Diametru Ø 38mm, 4 m lungime	190
IM0004304	Diametru Ø 43mm, 4 m lungime	205
IM0005004	Diametru Ø 50mm, 4 m lungime	207

Convertizor de inalta frecventa seria NW (nu include lance)

IM0000586	NW 0586 Convertizor 2kVA - 400V, 28A, functioneaza cu 2 lancei Ø 38/50mm sau 1 lance Ø60mm	718
IM0000600	NW 0600 Convertizor 3 kVA - 400V, 42A, functioneaza cu 3 lancei Ø 38/50mm sau 2 lancei Ø60/70mm	1.022



Convertizor de inalta frecventa seria ST (nu include lance)

IM0000482	ST 0482 Convertizor 1 kVA - 400V, 14A, functioneaza cu 1 lance Ø 38/50mm	525
IM0000486	ST 0486 Convertizor 2 kVA - 400V, 28A, functioneaza cu 2 lancei Ø 38/50mm sau 1 lance Ø 60mm	677
IM0000488	ST 0488 Convertizor 1 kW - 230V, 14A, functioneaza cu 1 lance Ø 38/50mm	509
IM0000490	ST 0490 Convertizor 1,5 kW - 230V, 21A, functioneaza cu 2 lancei Ø 38/50mm sau 1 lance Ø 60mm	663



Lance si cap vibrant pentru convertizor de inalta frecventa seriile NW / ST

IM0000470	Diametru Ø 38mm, 5 m lungime	296
IM0000472	Diametru Ø 50mm, 5 m lungime	361
IM0000478	Diametru Ø 60mm, 5 m lungime	431
IM0000474	Diametru Ø 70mm, 5 m lungime	523



Cap vibrant pentru convertizor de inalta frecventa seriile NW si ST

IM0000471	Diametru Ø 38mm	164
IM0000473	Diametru Ø 50mm	197
IM0000479	Diametru Ø 60mm	251
IM0000475	Diametru Ø 70mm	373



Rigla vibranta Mosquito (nu include rigla)

IM1007043	MSE Mono , Vibratii 11.000 vpm, motor electric 230V, 110 W	513
-----------	---	-----



IM1007042	MSH Honda GX25 , Vibratii 7.000 vpm, motor benzina 1 cp	863
-----------	--	-----



Rigle compatibile cu ambele modele:

IM0007047	Lungime 1,5 m	89,1
IM0007046	Lungime 2 m	116
IM0007045	Lungime 2,5 m	143
IM0007044	Lungime 3 m	169



Cod produs	Descriere produs	Pret Euro (fara TVA)
BT60E	BT60E Elicopter pentru pardoseala 600 mm Motor electric 1,5 kW, 230V / 50 Hz, ambreiaj centrifugal Maner pliabil, vibratii 1,1 - 1,5 m/s Nivel zgomot: 97 - 103 Lwa Greutate echipament: 55 kg Dimensiuni: 1.490x910x600 mm	la cerere
BT60H	BT60H 160 Elicopter pentru pardoseala 600 mm Motor Honda GX160, 5,5 cp, ambreiaj centrifugal Maner pliabil, vibratii 1,1 - 1,5 m/s Nivel zgomot: 97 - 103 Lwa Greutate echipament: 63 kg Dimensiuni: 1.490x910x600 mm	la cerere
BT90HF	BT90HF 160 Elicopter pentru pardoseala 900 mm Motor Honda GX160, 5,5 cp, ambreiaj centrifugal Maner pliabil, vibratii 1,1 - 1,5 m/s Nivel zgomot: 97 - 103 Lwa Greutate echipament: 78 kg Dimensiuni: 1.850x960x960 mm	la cerere
BT120H	BT120H 270 Elicopter pentru pardoseala 1.200 mm Motor Honda GX270, 9.0 cp, ambreiaj centrifugal Maner fix, vibratii 1,1 - 1,5 m/s Nivel zgomot: 97 - 103 Lwa Greutate echipament: 118 kg Dimensiuni: 2.130x1.040x1.250 mm	la cerere
F60412	Pale standard 600mm (set 4 buc)	24,6
F60412P	Pale din polipropilena / Combinate 600mm (set 4 buc) albe	54,7
F90416	Pale standard 900mm (set 4 buc)	33,9
C90419	Pale combinate 900mm (set 4 buc)	45,9
FS9043	Pale special combo 900mm (set 4 buc)	41,7
F120416	Pale standard 1.200mm, 1,6mm (set 4 buc)	39,2
C120419	Pale combinate 1.200mm (set 4 buc)	57,9
FS12043	Pale special combo 1.200mm (set 4 buc)	50,4
	 <p>Pale standard 600 Pale polipropilena Pale standard (900 si 1200) Pale combo Pale combinate</p>	
FP604	Disc comparator Galvanizat pentru finisare beton, diam. 600mm	53,5
FP9408P	Disc comparator Vopsit pentru finisare beton, diam. 900mm	99,9
FP11708P	Disc comparator Vopsit pentru finisare beton, diam. 1.200mm	163
		
IMBT350072	Lipa pentru nivelarea, finisarea si perierea betonului, 900mmx200mm Set livrare: Maner compus din 3 elemente x 1,8 m, suport prindere, lipa si perie finisare.	458
		



Cod produs	Descriere produs	Pret Euro (fara TVA)
MK1003661	UH070 Centrala hidraulica Debit 20,5 l/min Presiune 117 bari Motor Subaru EX21 Rezervor combustibil 3,2l, autonomie 2 ore la capacitate maxima Greutate: 44kg	2.717
MK0004735	BH 051V Ciocan hidraulic 5,5kg 2.700bpm Optional spit 240mm lungime si dalta 240mm lungime	1.934
MK0003655	BH 112V Ciocan hidraulic 11kg 1.450bpm Optional spit 450mm lungime si dalta 450mm lungime	1.810
MK0003656	BH 116V Ciocan hidraulic 16,5kg 1.650bpm Optional accesorii compatibile Spit - lungime 450mm Dalta - lungime 450mm Dalta latime 75mm, lungime 450mm Dalta latime 125mm, lungime 380mm	2.242
	BH 116VC Ciocan hidraulic 21.5kg 1.650bpm Optional accesorii compatibile Spit - lungime 450mm Dalta - lungime 450mm Dalta latime 75mm, lungime 450mm Dalta latime 125mm, lungime 380mm	2.527
MK0003657	BH 201V Ciocan hidraulic 26kg 1.050bpm Optional accesorii compatibile Spit - lungime 450mm Dalta - lungime 450mm Dalta latime 75mm, lungime 450mm Dalta latime 125mm, lungime 380mm	2.474
MK0004741	CH 130 Fierastrau circular diam. max 300mm, 3.200 rpm, 8kg	2.320
MK1003661	PH 301 Pompa submersibila diam. 3", debit 780 l/min. UH070-EXH Set furtune flexibile 5 m lungime	2.717 395



BISONTE CONSTRUCTII



Compactare
Pagina 19



**Masini de taiat
asfalt/beton**
Pagina 22



**Masini de taiat
caramida/BCA/metale**
ghilotina pavele
Pagina 23



**Discuri diamantate
segmentate**
Pagina 24



**Masini de taiat
gresie/faianta**
Ghilotina
Pagina 25



**Elicoptere pentru
slefuit si finisat
pardoseli**
Pagina 26



**Sisteme vibrare
beton**
Pagina 27



**Pompe pentru
gleturi | tencuit**
Pagina 28



**Pompe airless
zugravit | vopsit**
Pagina 32



Slefuire pereti | tavan
Aspiratoare
si malaxoare
Pagina 37



**Compressoare
electrice**
Pagina 39



Aparate de sudura
Taiere cu plasma
Pagina 41



**Scari profesionale
si universale**
Pagina 43



Betoniere
Roabe
Pagina 45



Masini de carotat
Pagina 46



**Generatoare
open**
Pagina 47



Cod produs	Descriere produs	Pret Euro (fara TVA)
BT1003674	MC75-H GXR Mai compactor 72kg Forta de impact: 13 kN Motor benzina Honda GX R120 - 4 timpi - 3,5 cp Sistem dublu de filtrare aer Rezervor pentru benzina din poliuretan Contor de ore si tuometru	1.740
	   	
6426390839831	MC72-H Mai compactor 68kg Forta de impact: 10kN Motor benzina Honda GX100 - 4 timpi - 2,8 cp Cadru de protectie impotriva avarierii motorului Rezervor pentru benzina din poliuretan Contor de ore si tuometru	1.480
	 	
BT1009479	MC72H-GXR Mai compactor 68kg Forta de impact: 10kN Motor benzina Honda GX120R - 4 timpi - 3,5 cp Cadru de protectie impotriva avarierii motorului Rezervor pentru benzina din poliuretan Contor de ore si tuometru	1.520
	 	
6426390839817	MC80-L Mai compactor 79kg Forta de impact: 10,7kN Motor benzina Loncin 168 - 4 timpi - 5,5 cp Cadru de protectie impotriva avarierii motorului Rezervor pentru benzina din poliuretan Contor de ore si tuometru	980
	  	
Optionale	BT0001847 Roti pentru transport mai compactor	42,1
	BT0004370 Ulei motor pe benzina, Italia Star 10W-40 fabricat in Romania, bidon 1L	5,4
		



Placi compactoare unidirectionale

Cod produs	Descriere produs	Pret Euro (fara TVA)
6426390839824	PC60-L Placa compactoare 54 kg, Forta compactare 10,5kN Motor Loncin 154F, 2,8 cp, 4 timpi, combustibil benzina Maner pliabil, roti transport incluse, protectie talpa	420
BT1003676	PC65-H Placa compactoare 60kg, Forta compactare 10,5kN Motor Honda GX160 - 4timpi - 5,5cp, combustibil benzina Manere pliabile, roti transport incluse, protectie talpa	890
6426390839855	PC70-H Placa compactoare 64kg, Forta compactare 11kN Motor Honda GX160 - 4timpi - 5,5 cp, combustibil: benzina Talpa masiva din otel turnat, protectie talpa Rezervor apa inclus, manere pliabile, roti transport incluse	960
6426390839848	PC70-L Placa compactoare 65 kg, Forta compactare 11,5 kN Motor Loncin 200F, 6,5 cp, combustibil benzina Talpa masiva din otel turnat, protectie talpa Manere pliabile, roti transport incluse	580
6426390839862	PC90-H Placa compactoare 95kg, Forta compactare 13kN Motor HondaGX160 - 4timpi - 5,5 cp, combustibil: benzina Talpa masiva din otel turnat, protectie talpa Rezervor apa inclus, manere pliabile, roti transport incluse	1.010
6426390839596	PC90-L Idem, motor Loncin G200F, 6,5 cp	690
BT1007064	PC90-B&S Idem, motor Briggs & Stratton, 6,5 cp	880
BT1004194	PC100-H Placa compactoare 102 kg; Forta compactare 20kN Motor Honda GX160 - 4 timpi 5,5 cp, combustibil benzina	990
Accesorii consumabile		
BT0001945	Protectie talpa PC65/70 pentru vibrocompactare pavele/dale	25,8
BT0001946	Set roti pentru transport placa compactoare Pc65	37,2
BT0004107	Rezervor apa PC90 (complet echipat)	97,7
BT0002784	Protectie talpa PC65 / PC70 incolor	43,4
BT0001951	Protectie talpa PC90 pentru vibrocompactare pavele/dale	28,1
BT0002785	Protectie talpa PC90 incolor	37,5
BT0001970	Set roti pentru transport placa compactoare PC90	37,2
BT0003595	Rezervor apa Pc70 (complet echipat)	97,7
BT0003772	Rezervor apa PC90 (doar rezervor)	82,6
BT0004370	Ulei motor pe benzina, Italia Star 10W-40 fabricat in Romania, bidon 1L	5,4





Placi compactoare reversibile

Cod produs	Descriere produs	Pret Euro (fara TVA)
BT1004922	PCR160-H Placa compactoare 160kg; Forta compactare 30,5kN Motor Honda, GX160, 5,5 cp Combustibil: benzina, maner pliabil Maneta mecanica schimbare sens-directie Talpa laminata, fara extensii (nu se pot atasa) Contor de ore si tuometru	1.400
BT1003679	PCR160-HE Idem, motor Honda GX160, 5,5 cp, talpa fonta cu extensii	1.650
BT1005981	PCR160-LE Idem, motor benzina Loncin G270F, 9 cp talpa fonta cu extensii	1.450
BT1003839	PCR255-H Placa compactoare 255kg; Forta compactare 38 kN Motor Honda GX270, 4 timpi - 8,5 cp Combustibil: benzina, maner pliabil Maneta mecanica schimbare sens-directie Extensii laterale incluse, contor de ore si tuometru	2.806
BT1006273	PCR255-H390 Idem, motor benzina Honda GX390, 13 cp	2.897
BT1004195	PCR255-L Idem, motor benzina Loncin G390F, 13 cp	1.955
BT1008988	PCR255-LK , Idem, motor diesel Lombardini / Kohler 15LD 350, 7,5 cp	3.066
BT1005621	PCR320-H Placa compactoare 305kg; Forta compactare 38kN Motor Honda GX390 - 4timpi - 11,7 cp, combustibil benzina Maner pliabil, maneta mecanica schimbare sens-directie Extensii laterale incluse, contor de ore si tuometru	3.513
BT1003231	PCR320-LK Idem, motor Diesel Lombardini / Kohler 15LD350, 7,5 cp	3.795
BT1004197	PCR400-H Placa compactoare 400kg, Forta compactare 40kN Motor Honda GX390 - 11,7 cp, combustibil benzina Sistem hidraulic pentru schimbare sens-directie Contor de ore si tuometru, manere pliabile	5.623
BT1004198	PCR400-LK , Idem, motor diesel Lombardini / Kohler 15LD440 - 10,9 cp	5.893
BT1003180	PCR520-LK Placa compactoare 520kg; Forta compactare 60kN Motor diesel Lombardini 15LD440 - 10,9 cp Pornire automata, baterie inclusa Sistem hidraulic pentru schimbare sens-directie Contor de ore si tuometru, manere pliabile	8.041
BT1005823	CV300-H Cilindru vibrocompactator 266 kg; Forta compactare 13,5 kN Motor Honda GX160, 5,5 cp, benzina Transmisie hidrostatica, latime rola 600 mm	4.980
BT0004370	Ulei motor pe benzina, Italia Star 10W-40 fabricat in Romania, bidon 1L	5,4





Masini de taiat asfalt / beton

Cod produs	Descriere produs	Pret Euro (fara TVA)
------------	------------------	----------------------

BT1006443+	MD350 Masina de debitat portabila cu suport taiere pentru sape, disc 350 mm	941
------------	--	-----

BT1006444	Adancime max. taiere 115 mm, motor benzina monocilindric in 2 timpi, putere motor 4 cp, turatie motor 8.500 rpm, rezervor combustibil 1,5 l Greutate: 12,5 kg	
-----------	--	--

BT1003680	MTA400-H Masina de taiat asfalt/beton diam. max. disc 400 mm	1.180
-----------	---	-------

	Motor benzina Honda GX200 - 4 timpi - 5,8 cp Adancime maxima de taiere 150mm Rezervor apa 25L din PPHD Manere reglabile; Maneta cu blocare pentru reglare adancime de taiere Contor de ore si tuometru Greutate utilaj: 90kg	
--	---	--



BT1007746	MTA400-H Idem, Motor benzina Honda GX270 - 4 timpi - 8,4 cp	1.490
-----------	--	-------

BT1005982	MTA400-L Idem cu motor Loncin G270F, 9 cp	940
-----------	--	-----



BT1006439	MTA401-H Masina de taiat asfalt /beton diam. max. disc 400 mm	1.650
-----------	--	-------

	Motor benzina Honda GX270, 4 timpi, 8,4 cp Adancime max. de taiere 150 mm Roti spate ajustabile central, stanga sau dreapta Greutate: 90 kg. Dimensiuni: LxIxh 670x560x1.400 mm	
--	--	--

MTA401-H



BT1005275	MTA501-H Masina de taiat asfalt/ beton diam. max. 500 mm	1.680
-----------	---	-------

	Motor Honda GX390 - 4 timpi - 11,7 cp, combustibil: benzina Adancime max. de taiere 185 mm, contor ore si tuometru Rezervor apa 35 l, conector rapid la bidon (se poate detasa pentru a-l reumple), coborare/ridicare usoara a discului datorita cilindrului cu gaz, reglare grila de indicare in functie de dimensiunea discului utilizat, curea transmisie disc mai lata, pin blocare adancime taiere	
--	---	--



BT1007065	MTA501-BS Idem, motor Briggs and Stratton, 13,5 cp	1.350
-----------	---	-------

BT1009540	MTA505H Masina de taiat asfalt/ beton diam. max. 500 mm	1.840
-----------	--	-------



	Motor Honda GX390 - 4 timpi - 13 cp, combustibil: benzina. Adancime max. de taiere 170 mm, contor ore si tuometru. Rezervor apa 40 l. Control reglabil pe inaltime a discului. Sistem mecanic pentru avans (permite optimizarea taierii si o durata de viata mai mare a discului)	
--	--	--



BT1009541	MTA505L Idem, motor Loncin G390F 13 cp, diam. max. disc 500 mm	1.240
-----------	---	-------



Discuri

BT0009536	Disc Ø=400mm, Ø interior 25,4, dim.segmente(h x grosime x L) 20x3,2x28 mm	60,0
-----------	---	------

BT0009537	Disc Ø=500mm, Ø interior 25,4, dim.segmente(h x grosime x L) 20x3,5x36 mm	99,3
-----------	---	------

BT0009532	Disc Ø=400mm, Ø interior 25,4, dim.segmente(h x grosime x L) 12x3,5x38 mm	101
-----------	---	-----

BT0009534	Disc Ø=500mm, Ø interior 25,4, dim.segmente(h x grosime x L) 12x4,0x38 mm	159
-----------	---	-----



BT1005239	MSB25-H Masina de scarificat asfalt / beton	3.604
-----------	--	-------

	Motor Honda GX390, 11,7 cp, turatie 3.400-3.600 rpm Latime de lucru 250 mm, Adancime 3 mm / trecere. Capacitate rezervor 6,1 l, Greutate 115 kg, Dimensiuni LxIxh 850x490x950 mm	
--	--	--

BT0001966	Disc - steluta pentru masina de scarificat - frezat (pret / bucata)	7
-----------	---	---

BT0004370	Ulei motor pe benzina, Italia Star 10W-40 fabricat in Romania, bidon 1L	5,4
-----------	---	-----





Masini de taiat caramida / metale

Cod produs	Descriere produs	Pret Euro (fara TVA)
BT1006434	KTV 400Ei Masina de taiat caramida, marmura, granit, pavele disc 400 mm Lungime taiere 450 mm, adancime taiere la a 2-a trecere 280 mm Motor 230V, 2,2 kW, turatie 2.850 rpm Greutat: 97 kg Dimensiuni: Lxlxh min./max. 1.160x715x1.430 / 1.520 mm	1.380
BT0009521	Disc diamantat segmentat Ø=400 mm, seria general pentru caramida, beton, marmura, granit - include segmente ingrosate	53,9
BT0009528	Disc diamantat segmentat, seria Silent, Disc Ø=400mm, pt. caramida, beton, marmura, granit, cu fante trasate laser pt. silentiozitate si durata lunga de viata.	83
BT1006433	KTV 650E Masina de taiat caramida, marmura, granit, pavele disc 650 mm, Lungime taiere 500 mm, adancime taiere la a 2-a trecere 510 mm Motor 400V, 5,5 kW, turatie 1.400 rpm Greutate: 230 kg Dimensiuni: Lxlxh min./ max. 1.700x1.500x820 mm	2.320
BT0009523	Disc diamantat Ø=650mm segmentat Ø=400 mm, seria general pt. caramida, beton, marmura, granit	188
BT1006435	GYD 400E Masina de taiat metale, disc 400 mm (nu este inclus) Adancime taiere la 90 de grade 100 x 60 mm Adancime taiere la 45 de grade 100 x 40 mm Motor 400V, 3 kW, turatie 2.850 rpm Greutate: 90 kg. Dimensiuni: Lxlxh 710x620x560 mm	1.402
BT1006443	MD350 Masina de debitat portabila (fara carut), geanta transport inclusa Disc 350mm, adancime de taiere 115 mm, motor monocilindric, 2 timpi, 4 cp, turatie motor 8.500 rpm, rezervor benzina 1,5 l Greutate echipament: 12,5 kg. Dimensiuni: Lxlxh 950x450x460 mm	789
BT2000544	Disc universal diamantat 350 mm (pentru MD350)	50,5
BT1009423	TSC470 Masina de taiat BCA , 230V – 1,85 kW, inaltime maxima de taiere 47 cm, masa reglabila 0-90°. Greutate: 185 kg	3.180
BT0009426	Lama continua pentru BCA/caramida (TSC470)	354
BT1009424	TSC505 Masina de taiat BCA/Caramida , 230V – 1,40 kW, inaltime maxima de taiere 50 cm, avans controlat. Greutate: 220 kg	5.480
BT0009427	Lama continua pentru BCA (TSC505)	394
BT1009425	TSC650 Masina de taiat BCA/Caramida , 230V – 1,85 kW, inaltime maxima de taiere 65 cm, masa reglabila 0-90°. Greutate: 207 kg	4.120
BT0009428	Lama continua pentru BCA (TSC650)	374

Inverter pentru protectia motorului la tensiune joasa



TSC470



TSC505



TSC650





Discuri Bisonte diamantate segmentate

Cod produs

Descriere produs

Pret Euro (fara TVA)

(Nou!) DISC DIAMANTAT SEGMENTAT - SERIA GENERAL

Pentru caramida, beton, marmura, granit - include segmente ingrosate cu durabilitate mare si rezistenta la deformare

BT0009547 Disc Ø=105mm, Ø interior 25,4, dim. segmente (h x grosime x L) 10x2,3x30 mm	8,3
BT0009548 Disc Ø=115mm, Ø interior 25,4, dim. segmente (h x grosime x L) 10x2,3x30 mm	9,4
BT0009549 Disc Ø=125mm, Ø interior 25,4, dim. segmente (h x grosime x L) 10x2,3x30 mm	10,5
BT0009550 Disc Ø=180mm, Ø interior 25,4, dim. segmente (h x grosime x L) 10x2,6x32 mm	16,5
BT0009521 Disc Ø=400mm, Ø interior 25,4, dim. segmente (h x grosime x L) 10x3,5x38 mm	53,9
BT0009522 Disc Ø=600mm, Ø interior 25,4, dim. segmente (h x grosime x L) 12x4,5x38 mm	164
BT0009523 Disc Ø=650mm, Ø interior 25,4, dim. segmente (h x grosime x L) 12x4,5x38 mm	188
BT0009524 Disc Ø=750mm, Ø interior 25,4, dim. segmente (h x grosime x L) 12x4,5x38 mm	266



(Nou!) DISC DIAMANTAT SEGMENTAT - SERIA SILENT

Pentru caramida, beton, marmura, granit - include segmente drepte si trapezoidale cu ascutire ridicata, in plus pe suprafata discului se gasesc fante trasate laser, care confera silentiozitate si durata lunga de viata.

BT0009525 Disc Ø=250mm, Ø interior 25,4, dim. segmente (h x grosime x L) 10x2,6x38 mm	34,3
BT0009526 Disc Ø=300mm, Ø interior 25,4, dim. segmente (h x grosime x L) 10x3,0x38 mm	53,6
BT0009527 Disc Ø=350mm, Ø interior 25,4, dim. segmente (h x grosime x L) 10x3,2x38 mm	61,8
BT0009528 Disc Ø=400mm, Ø interior 25,4, dim. segmente (h x grosime x L) 10x3,5x38 mm	83
BT0009529 Disc Ø=500mm, Ø interior 25,4, dim. segmente (h x grosime x L) 10x4,0x38 mm	166
BT0009530 Disc Ø=600mm, Ø interior 25,4, dim. segmente (h x grosime x L) 10x4,5x38 mm	290



(Nou!) DISC DIAMANTAT SEGMENTAT - SERIA ASFALT

Pentru asfalt, beton proaspat (sapa), beton - dedicat taierii de asfalt si beton proaspat cu masini profesionale de putere max.40 CP

BT0009531 Disc Ø=350mm, Ø interior 25,4, dim.segmente(h x grosime x L) 12x3,2x38 mm	78,1
BT0009532 Disc Ø=400mm, Ø interior 25,4, dim.segmente(h x grosime x L) 12x3,5x38 mm	101
BT0009533 Disc Ø=450mm, Ø interior 25,4, dim.segmente(h x grosime x L) 12x3,5x38 mm	126
BT0009534 Disc Ø=500mm, Ø interior 25,4, dim.segmente(h x grosime x L) 12x4,0x38 mm	159



(Nou!) DISC DIAMANTAT SEGMENTAT - SERIA TURBO-A

Disc diamantat segmentat alternativ, beton rutier, asfalt si beton proaspat (toate tipurile de sapa), include trei tipuri de segmente, dispuse alternativ pe disc, tehnologie prin sudare laser DrFritsch Germania

BT0009535 Disc Ø=350mm, Ø interior 25,4, dim.segmente(h x grosime x L) 20x3,2x24 mm	50,7
BT0009536 Disc Ø=400mm, Ø interior 25,4, dim.segmente(h x grosime x L) 20x3,2x28 mm	60,0
BT0009537 Disc Ø=500mm, Ø interior 25,4, dim.segmente(h x grosime x L) 20x3,5x36 mm	99,3



BT2000544 Disc universal diamantat 350 mm, prindere 25.4 mm compatibil cu MD350	50,5
BT0001848 Disc diamantat 400mm - STANDARD - pentru taiere asfalt/beton	93,6
BT0001849 Disc diamantat 400mm - LONG LIFE - pentru taiere asfalt/beton	119
BT0001850 Disc diamantat 500mm - STANDARD - pentru taiere asfalt/beton	159
BT0001851 Disc diamantat 500mm - LONG LIFE - pentru taiere asfalt/beton	185

**LICHIDARE
STOC**



Masini de taiat gresie / faianta Ghilotina pavele

Cod produs

Descriere produs

Pret Euro (fara TVA)

Masini de taiat gresie / faianta LEGGERA

Caracteristici:

Multifuncțional, putere și precizie sunt principalele caracteristici ale acestui echipament pentru taiat gresie și faianta;

LEGGERA poate tăia rapid și precis toate tipurile de gresie și faianta, cu grosimea de la 5 la 15 mm.

Chiar și tăierea diagonală este sigură și simplă;

Echipament proiectat pentru tăierea tuturor tipurilor de ceramică disponibile, porțelan și plăci de sticlă, inclusiv mozaic de sticlă;

Mâner ergonomic precis și extrem de puternic;

Transportul și depozitarea sunt rapide și ușoare;

Masina este dotată cu picioruse cauciucate antiderapante;

Incizia se efectuează prin împingere – metoda eficientă în cazul tuturor tipurilor de materiale;



8021410068420 **Leggera 70**, L.max. 670 mm, grosime de taiere 5-15 mm, dimensiune max. a 160

(Nou!) placii pentru taieri pe diagonala 470x470 mm, rotita taiere Ø 15 x 6 x 1,5 mm



8021410068437 **Leggera 92**, L.max. 920 mm, grosime de taiere 5-15 mm, dimensiune max. a 205

(Nou!) placii pentru taieri pe diagonala 650x650 mm, rotita taiere Ø 15 x 6 x 1,5 mm



8021410068444 **Leggera 137**, L.max. 1.370 mm, grosime de taiere 5-15 mm, dimensiune max. 265

(Nou!) a placii pentru taieri pe diagonala 965x965 mm, rotita taiere Ø 15 x 6 x 1,5 mm



Masina de taiat gresie / faianta BASIC 60

Caracteristici:

Multifuncțional, putere și precizie sunt principalele caracteristici ale acestui echipament pentru taiat gresie și faianta;

BASIC poate tăia rapid și precis toate tipurile de gresie și faianta, cu grosimea de la 4 la 12 mm.

Chiar și tăierea diagonală este sigură și simplă;

Echipament proiectat pentru tăierea tuturor tipurilor de ceramică disponibile, porțelan și plăci de sticlă, inclusiv mozaic de sticlă;

Mâner ergonomic precis și extrem de puternic;

Transportul și depozitarea sunt rapide și ușoare;

Masina este dotată cu picioruse cauciucate antiderapante;

Incizia se efectuează prin împingere - metoda eficientă în cazul tuturor tipurilor de materiale;

5.000.000 de cicluri garantate fără uzură.

• Fără lubrifiere (Cuplul din crom și IXEF este auto-lubrifiat).

• Fără mentenanță (Bare cromate foarte rezistente).

3161304182391 **Basic 60**, L.max. 600 mm, grosime de taiere 4-12 mm, dimensiune max. a 82,0

(Nou!) placii pentru taieri pe diagonala 420x420 mm, rotita taiere Ø 15 x 6 x 1,5 mm



8021410020091 Rotita taiere pentru masinile Leggera și Basic 60

6,0



BT1001919 **GP42 Ghilotina** manuala pentru taiat pavele și prefabricate usoare din beton 208

Latime max.420mm

Inaltime max. 140mm

BT0002559 Set 2 buc. lame ghilotina GP42

13,1





Elicoptere pentru slefuit / finisat pardoseli

Cod produs	Descriere produs	Pret Euro (fara TVA)
BT1004524	EP600-E Masina de slefuit sapa/beton - Elicopter cu diam. 600mm Motor electric 230V, 2,2 kW Maner pliabil, 4 palete standard incluse Greutate utilaj: 45 kg	890
BT1004525	EP600-H Masina de slefuit sapa/beton - Elicopter cu diam. 600mm Motor Honda GX160 - 4 timpi - 5,5 cp, combustibil: benzina Maner pliabil, 4 palete standard incluse Greutate utilaj: 60kg	950
BT1003682	EP900-H Masina de slefuit sapa/beton - Elicopter cu diam. 900mm Motor Honda GX160 - 4 timpi - 5,5 cp, combustibil: benzina Maner pliabil, 4 palete standard incluse Greutate utilaj: 80kg	980
BT1003841	EP1200-H Masina de slefuit sapa/beton - Elicopter cu diam. 1.200mm Motor Honda GX270 - 4 timpi - 8,5 cp, combustibil: benzina Maner pliabil, 4 palete standard incluse Greutate utilaj: 99kg	1.340
BT0002438	Pale standard 600mm (set 4 buc.)	30,4
BT0006634	Pale combinate 600mm (set 4 buc.)	37,5
BT0006631	Pale special Combo 600mm (set 4 buc.)	51,5
BT0002451	Pale standard 900mm (set 4 buc.)	37,5
BT0006635	Pale combinate 900mm (set 4 buc.)	63,2
BT0006632	Pale special combo 900mm (set 4 buc.)	58,4
BT0002257	Pale standard 1.200mm (set 4 buc.)	49,2
BT0006636	Pale combinate 1.200mm (set 4 buc.)	53,8
BT0006633	Pale special Combo 1.200mm (set 4 buc.)	72,6
BT0001931	Disc comparator pentru finisare beton, diam. 600mm	53,8
BT0001934	Disc comparator pentru finisare beton, diam. 900mm	77,2
BT0002256	Disc comparator pentru finisare beton, diam. 1.200mm	98,3
Lipa manuala pentru finisat beton, lungime maner 5 m (2 x 2,5m)		
BT1005984	Maner lipa compatibil cu profilurile de mai jos Tip 1 - Profil rectangular din aluminiu	159
BT1005985	Lungime rigla 2,44 m	67,9
BT1005986	Lungime rigla 3 m Tip 2 - Aluminiu extrudat capete rotunjite	91,3
BT1005987	Lungime rigla 1,22 m	131
BT1005988	Lungime rigla 1,83 m Tip 3 - Tabla, capete rotunjite	211
BT1005989	Lungime rigla 1,22 m	63,2
BT1005990	Lungime 1,53 m	79,6
BT1005991	Lungime 1,83 m	93,6
BT1005992	Carucior pentru imprastiere materiale finisaj pardoseli Capacitate transport 150kg / 0,18m ³	1.090





Sisteme de vibrare a betonului

Cod produs	Descriere produs	Pret Euro (fara TVA)
BT1001822	VIB-E Vibrator pentru uz in imersie beton Motor electric cu putere de 550W, alimentare 230V-50Hz Viteza de lucru: 2.800rpm Greutate utilaj: 7,2kg	155
BT0001823	Lance vibrare 4m lungime, cap vibrare diam. 28mm	103
BT0001824	Lance vibrare 4m lungime, cap vibrare diam. 32mm	112
BT0001825	Lance vibrare 4m lungime, cap vibrare diam. 38mm	115
BT0001826	Lance vibrare 4m lungime, cap vibrare diam. 45mm	122
BT1002258	VIB-DE Plus Vibrator pentru uz in imersie beton Motor electric cu putere de 2.300W, alimentare 230V-50Hz Viteza de lucru: 18.000 rpm Greutate utilaj: 8kg	295
BT1005234	Lance + cap vibrare 4 m lungime, Ø38 mm	236
BT1005235	Lance + cap vibrare 5 m lungime, Ø38 mm	250
BT1005617	Lance + cap vibrare 4 m lungime, Ø48 mm	262
BT1005618	Lance + cap vibrare 5 m lungime, Ø48 mm	276
BT1005619	Lance + cap vibrare 5 m lungime, Ø58 mm	311
BT1005236	VIB-H Vibrator pentru uz in imersie beton Motor Honda GX35 4 timpi, 1,3 cp, combustibil benzina Viteza de lucru: 7.500 rpm Greutate utilaj: 7,5 kg Vibratorului VIB-H i se adauga o lance de mai jos:	520
BT1005237	Lance vibrare 3m lungime, cap vibrare diam. 32 mm	81,9
BT1005238	Lance vibrare 3m lungime, cap vibrare diam. 38 mm	88,9
Rigle vibrante motorizare Honda cu 1 sau 2 manere		
BT1009554	RVB2-K Rigla vibranta, motor KASEI 140FA - 4timpi - 1,2 cp (2 manere) Greutate utilaj: 16.5 kg	489
BT1004944	RVB1-H Rigla vibranta, Motor Honda GX35 - 4timpi - 1,3 cp (1 maner) Greutate utilaj: 20 kg	845
BT1003818	RVB2-H Rigla vibranta, Motor Honda GX35 - 4timpi - 1,3 cp (2 manere) Greutate utilaj: 20 kg	880
BT0002590	Rigla aluminiu pentru vibrare beton, lungime 1,9m	84
BT0001852	Rigla aluminiu pentru vibrare beton, lungime 2,5m	112
BT0001853	Rigla aluminiu pentru vibrare beton, lungime 3m	136
BT0003360	Rigla aluminiu pentru vibrare beton, lungime 3,7m	171
BT0001854	Rigla aluminiu pentru vibrare beton, lungime 4,5m	171
BT0004370	Ulei motor pe benzina, Italia Star 10W-40 fabricat in Romania, bidon 1L	5,4





Pompe cu Snec pentru Gleturi si Decorative

Cod produs	Descriere produs	Pret Euro (fara TVA)
------------	------------------	----------------------

BT1008427	PCS-T5 Pompa cu Snec pentru Gleturi si Decorative	1.980
-----------	--	-------

Utilaj echipat complet, gata de lucru
 Debit material: 15 l/min.;
 Granulometrie max. 3 mm; Presiune max. 20 bar
 Capacitate recipient material: 40 l
 Motor electric: 230V - 50 Hz, 3,4 kW; Greutate: 42 kg
Echipare standard: 1 rotor; 1 stator; 1 lance aplicare material; 3 duze metalice; 6 bureti curatare furtun; 1 furtun material diam. 19 mm, cuplaje rapide, 117 bar; 1 furtun aer, cuplaje rapide, 13 mm; 1 perie curatare



Bt2008428	Rotor pentru PCS-T5	76,3
BT2008429	Stator pentru PCS-T5	46,9
BT7009002600	Rotor Mixer 8 pentru PCS-T5	80,5
BT3F00528400	Stator Mixer 8 pentru PCS-T5	67,0
BT0008877	Duza metalica 4 mm	4,8
BT0008878	Duza ceramica 6 mm	4,8
BT0008879	Duza ceramica 8 mm	4,8
BT0008942	Lance aplicare material	116



BT1008866	PCS - HP15 Pompa cu Snec pentru Gleturi si Decorative	5.341
-----------	--	-------

Utilaj echipat complet, gata de lucru
 Debit material: 6 l/min.;
 Granulometrie max. 1 - 2 mm; Presiune max. 120 bar
 Capacitate recipient material: 57 l
 Motor electric: 230V - 50 Hz; 2,2 kW; Greutate: 62 kg
Echipare standard: 1 rotor; 1 stator; 1 pistol airless; 1 duza 443; 1 garda protectie duza; 1 furtun material 15m, diam. 16 mm; 1 cablu comanda electrica 10 m; 1 kit filtrare pe furtun mesh 18; 1 manometru



Accesorii si consumabile PCS-HP15

BT7009107700	Rotor Mixer Jet 2	135
BT3F00529100	Stator Mixer Jet 2	109

BT1008870	Kit tencuieli decorative (necesar compresor de min. 330 l/min)	517
-----------	---	-----

Kit-ul conține: 1 x Furtun aer 10m, sistem conexiune Geka;
 1 x Adaptor pentru pistol cu sistem de dozare a aerului (se montează pe pistol pentru facilitarea amestecului material-aer);
 3 x Duze pulverizare pentru decorativă, Ø 4, 5 si 6 mm;
 2 x Bureți spongioși pentru curățare furtun material.



BT1008869	Kit zugraveli	909
-----------	----------------------	-----

Kit-ul conține: 1 x Furtun de material Ø 13 mm, lungime 15 m, dotat cu o supapă unisens pentru un debit constant de material;
 1 x Cablul comanda electrica;
 1 x Pistol airless cu comandă electrică;
 1 x Element de susținere a duzei (guard tip);
 Nota: Duza airless nu este inclusă.



BTEU30829	Filru mesh 10 grosier	26,8
BTEU30667	Filtru mesh 18 mediu	26,8
BTEU30668	Filtru mesh 30 fin	26,8





Masini de tencuit

Cod produs	Descriere produs	Pret Euro (fara TVA)
------------	------------------	----------------------

BT1008757 PCS-K4 Masina de tencuit trifazic - Utilaj echipat complet, gata de lucru **4.870**

Debit material: 40 l/min. Granulometrie max. 0-3 mm; Presiune max. 5.5 bar
 Capacitate recipient material: 130 l. Motor electric: 400V - 50 Hz, 6.4 kW
 Compresor aer: 250 l/min. - 5,5 bar. Greutate masina: 285 kg
 Suport integrat pentru montarea rotorului in statorul cu pin



Echipare standard: Compresor; Pompa apa; Gratar detasabil cu rupere a sacului; 4 roti din care 2 directionale si 1 cu frana; Stator si rotor D 6-3; Cablu cu stecher 25m; Furtun material 15 m, diam. 25mm; Furtun apa 10m, diam. 19 mm; Furtun aer 16 m, diam. 9.52 mm; Mixer standard; Lance L 70 cm

BT1008758 PCS-K35 Masina de tencuit monofazica - Utilaj echipat complet, gata de lucru. **5.980**

Debit material: 20 l/min. Granulometrie max. 0-3 mm;
 Presiune max. 5.5 bar Capacitate recipient material: 130 l
 Putere motor instalata: 230V - 50 Hz, 4.9 kW
 Compresor aer DELTA Germania: 180 l/min. - 3,8bar. Greutate masina: 285kg

NOU!
 Compresor
 DELTA
 Germania



Echipare standard: Compresor; Pompa apa; Gratar detasabil cu rupere a sacului; 4 roti din care 2 directionale si 1 cu frana; Stator si rotor D 6-3; 1 cablu cu stecher 25m; Furtun material 15 m, diam. 25mm; Furtun apa 10m, diam. 19 mm; Furtun aer 16 m, diam. 9.52mm; Mixer standard; Lance L 70 cm

Accesorii / consumabile pentru pompele de tencuiala

BT0008873 Rotor Mixer 1 Italia D6-3 **54,0**

BT0008871 Stator Mixer 1 Italia D6-3 Drept **38,0**

BT0008872 Stator Mixer 1 Italia D6-3 Turbo Twister **40,0**

Debit max.: 22 l/min
 Presiune max.: 30 bar
 Granulometrie max.: 3 mm



BT0008876 Rotor Mixer 2 Italia D7-2.5 **54,0**

BT0008874 Stator Mixer 2 Italia D7-2.5 Drept cu pin blocaj **40,0**

BT0008875 Stator Mixer 2 Italia D7-2.5 Turbo Twister cu pin blocaj **43,0**

Debit max.: 27 l/min
 Presiune max.: 30 bar
 Granulometrie max.: 3mm



BT7009029000 Rotor Mixer 3 Italia D8-2 **52,0**

BT3F00612100 Stator Mixer 3 Italia D8-2 **38,0**

Debit max.: 32 l/min
 Presiune max.: 25 bar
 Granulometrie max.: 3mm

BT7009012500 Rotor Mixer 30 pentru PCS-K35 **54,0**

BT3F00618000 Stator Mixer 30 pentru PCS-K35 **42,0**

Debit max.: 25 l/min
 Presiune max.: 20 bar
 Granulometrie max.: 3mm

BT7009009000 Rotor Mixer 32 pentru PCS-K35 **54,0**

BT3F00618500 Stator Mixer 32 pentru PCS-K35 **40,0**

Debit max.: 30 l/min
 Presiune max.: 25 bar
 Granulometrie max.: 3mm



BT7009049500 Rotor Mixer 4 Italia **52,0**

BT3F00613000 Stator Mixer 4 Italia **38,0**

Debit max.: 40 l/min
 Presiune max.: 25 bar
 Granulometrie max.: 3mm

BT0009103 Capac Siloz PCS-K4 **440**

BT0009104 Senzor pentru Siloz PCS-K4 **418**



BT1008881 Lance din aluminiu pentru aplicare material L45 cm; D35 mm **64,1**

BT1008882 Lance din PPR pentru aplicare material L70 cm; D25 mm **65,0**

BT1009102 Lance din PPR pentru aplicare material L120 cm; D25 mm **65,0**

BT2008883 Duza 12 mm **1,8**

BT2008884 Duza 14 mm **1,8**

BT0008886 Mixer Standard pentru PCS-K4 si PCS-K35 **29**



Masini pentru aplicat gleturi de nivelare si finisare / decorativa

Cod produs

Descriere produs

Pret Euro (fara TVA)

BT1009071 **PCS-MS100 Pompa pentru aplicat gleturi de nivelare si finisare / decorativa**

7.800

Debit material 6 l/min.
Granulometrie max. 1 mm, presiune max. 110 bar
Capacitate cuva material 60 l
Motor electric 230V / 50 Hz; Putere motor 2.2 kW
Duza max. 0.045"
Greutate echipament 88 kg; Dimensiuni 1.230x720x660 mm

Specificatii Mixer PCS-MS100

Volum cuva material 40 l
Voltaj 230V / 50 Hz; Putere motor 0.75 kW
Turatie malaxor inainte / inapoi 280 rpm
Distributor de apa reglabil incorporat
Greutate 41 kg; Dimensiuni 810x720x660 mm

Echipe standard:

Pompa PCS-MS100; mixer; stator si rotor Mixer Jet 2; 1 furtun material diam. 16 mm, 20m lungime; manometru; pistol cu garda de protectie pentru duza; duza 443

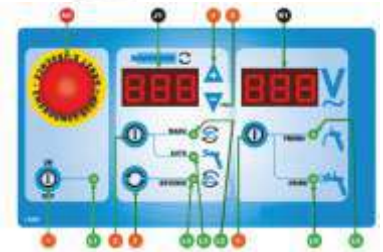

BT3F00529100 **Stator Mixer Jet 2** debit material 10 l/min.; turatii 400 rpm; presiune 140 bar
Granulometrie max. 2 mm; diametru stator 51 mm, 310 mm lungime

109

BT7009107700 **Rotor Mixer Jet 2** turatii 400 rpm

135



BT1008870 **Kit tencuieli decorative**

517

1 furtun aer 10m lungime, conexiune Geka
1 Adaptor pentru pistol cu sistem de dozare a aerului (se monteaza pe pistol pentru facilitarea amestecului material - aer)
3 duze pulverizare pentru decorativa diametru 4, 5 si 6 mm
2 bureti spongiosi pentru curatare furtun material



BT1008869 **Kit zugraveli**

909

1 furtun material diametru 13 mm, 15 m lungime dotat cu supata unisens pentru un debit constant de material
1 cablu comanda electrica
1 pistol airless cu comanda electrica
1 cap protectie duza



BTEU30829 Filtru mesh 10 grosier

26,8

BTEU30667 Filtru mesh 18 mediu

26,8

BTEU30668 Filtru mesh 30 fin

26,8





Masini pentru aplicat gleturi de nivelare si finisare / decorativa

Cod produs

Descriere produs

Pret Euro (fara TVA)

BT9110007300 **PCS-MX10 Pompa multifunctionala cu snec pentru tencuieli si gleturi preamestecate** 3.529

preamestecate

Debit material 8-26 l/min.

Granulometrie max. 3 mm, presiune pulverizare 0-20 bar

Capacitate cuva material 30 l

Motor electric 230V / 50 Hz; Putere motor 2.2 kW

Greutate echipament 55 kg; Dimensiuni 900x450x620 mm

Caracteristici PCS-MX10:

Mașină compactă și versatilă.

Ideala pentru mortare, adezivi, rosturi și finisaje.

Utilizati impreuna cu mixerul continuu orizontal Bisonte MIX PRO 70 pentru eficienta si calitate maxima.

Echipare standard:

1 x Spray degripant

1 x 15 m furtun material Ø 25

1 x 16 m furtun aer Ø 13 GEKA

1 x Lance pentru materiale preamestecate

1 x Kit de întreținere



OPTIONAL

BT8100005700 **Kit aplicare adezivi, hidroizolatii, glet, tinci** 819

Include: Lance aplicare adezivi, cablu lance 17 m, kit de pulverizare lance de finisare



4004025075537 **Compresor electric Wagner C330/03** 808

Debit aer 330 l/min, presiune de lucru 10 bar, capacitate rezervor aer 3 l



BTEU30915 **MIX PRO 70 Malaxor orizontal continuu pentru glet** 3.980

Debit material 250 l/h.

Granulometrie max. 3 mm, presiune pulverizare 0-20 bar

Capacitate cuva material 30 l

Motor electric 230V / 50 Hz, 10A; Putere motor 0,75 kW

Greutate (cu cadru): 60kg; Dimensiuni de lucru (cu cadru) 980x730x1.290 mm

Caracteristici MIX PRO 70:

Malaxorul MIXPRO 70 permite o amestecare rapidă și omogenă a produselor sub formă de pulbere.

Este echipat cu un regulator de viteză și apometru.

Cadru reglabil în 4 poziții.

Se pot folosi toate tipurile de produse pulbere monocomponente.

Panou de control cu afișaj digital ușor de utilizat.





Pompe airless pentru zugravit / vopsit

Cod produs

Descriere produs

Pret Euro (fara TVA)

BT1009042 PAZ20X Pompa airless cu piston pentru zugraveli/vopsitorii (cuva incl.)

590

Motor electric 1.100W, alimentare 230V - 50 Hz
Debit de lucru 2 l/min. Duza max. 0,021"
Presiune de lucru 200 bar, vascozitate medie - mare
Pachet livrare standard: cuva material 6L, pistol airless, duza 519, 15m furtun airless 1/4", extensie pistol 45 cm, ulei de lubrifiere



BT1009453 PAZ20X Pompa airless cu piston pentru zugraveli/vopsitorii (fara cuva)

550

BT1009449 Cuva material 6L pentru PAZ-20X

29,0

BT1009043 PAZ24X Pompa airless cu piston pentru zugraveli/vopsitorii

740

Motor electric 1.300W, alimentare 230V - 50 Hz
Debit de lucru 2,4 l/min. Duza max. 0,023"
Presiune de lucru 227 bar, vascozitate medie - mare
Pachet livrare standard: pompa, pistol airless, duza 517, 15m furtun airless 1/4", extensie pistol 45 cm, ulei de lubrifiere



BT1009044 PAZ28X Pompa airless cu piston pentru zugraveli/vopsitorii

940

Motor electric 2.200W, alimentare 230V - 50 Hz
Debit de lucru 2,8 l/min. Duza max. 0,025"
Presiune de lucru 227 bar, vascozitate medie - mare
Pachet livrare standard: pompa, carucior, pistol airless, duza 517, 15m furtun airless 1/4", extensie pistol 45 cm, ulei de lubrifiere



BT1009391 PAZ32X Pompa airless cu piston pentru zugraveli/vopsitorii

1.320

Motor electric 2.600W, alimentare 230V - 50 Hz
Debit de lucru 3,2 l/min. Duza max. 0,031"
Presiune de lucru 227 bar, vascozitate medie - mare
Pachet livrare standard: pompa, carucior, 2 pistoale airless, 2 x duze 517, 15m furtun airless 1/4", extensie pistol 45 cm, ulei de lubrifiere
Poate lucra cu 2 pistoale simultan



BT1009561 PAZ51X Pompa airless cu piston pentru zugraveli/vopsitorii

1.840



Motor electric 3.000W, comanda EPC digital, alimentare 230V - 50 Hz
Debit de lucru 5,1 l/min. Duza max. 0,037"
Presiune de lucru 227 bar, vascozitate admisa mare
Pachet livrare standard: 1 pistol airless, carucior, 2 x duze (525/531), 1 x 15m furtun airless 3/8", extensie pistol 45 cm, ulei de lubrifiere.





Pompe airless pentru zugravit / vopsit

Cod produs

Descriere produs

Pret Euro (fara TVA)

BT1009392 **PAZ81X Pompa airless cu piston pentru zugraveli/vopsitorii** 2.490

Motor electric 4.500W, comanda EPC digital, alimentare 230V - 50 Hz

Debit de lucru 8,0 l/min. Duza max. 0,045"

Presiune de lucru 227 bar, vascozitate admisa mare

Pachet livrare standard: 2 pistoale airless, carucior, 3 x duze (525/535/541), 2

x 15m furtun airless 3/8", furtun 1/2-15m, furtun 3/8 - 1m, furtun 1/4 - 1m

Extensie pistol 45 cm, ulei de lubrifiere. Poate lucra cu 2 pistoale simultan



BT1009393 **Cuva material 60L** (include conector pentru pompa **PAZ-81X** si capac) 345

BT1009394 **Sistem presare/roluire saci** pentru evacuare materiale semifluide 165

(se conecteaza la rezervor)



BT1006390 **PAZ-9600e Pompa airless hidraulica pentru vopsit / zugravit si gleturi lichide** 4.915

Piston hidraulic angrenat de motor electric 6,7 kW - 400V, transmisie curea

Debit material 10 l/min., duza max. 0.056"

Presiune de lucru 228 bar, vascozitate admisa mare

Dotare standard: pistol airless cu duze airless 537 si 243, 15 m furtun 3/8", 1m

furtun pentru manevrare 1/4"

Greutate echipament 89 kg; Dimensiuni 1.200x750x1.200 mm



BT0008069 **PAZ-9800e Pompa airless hidraulica pentru vopsit / zugravit si gleturi lichide** 3.044

Piston hidraulic angrenat de motor electric 3,75 kW, 230V, transmisie directa

Debit material 10 l/min, duza max. 0.041"

Presiune de lucru 220 bar, vascozitate admisa mare

Dotare standard: pistol airless cu duze 435 si 341, 15 m furtun 3/8",

extensie pistol 50 cm, ulei lubrifiere

Greutate echipament 97 kg; Dimensiuni 1.080x660x1.020 mm



POMPA AIRLESS CU MEMBRANA

6426390839602 **PAZ-6860e Pompa airless cu membrana pentru zugraveli/vopsitorii** 735

Motor electric 1.800W, alimentare 230V - 50 Hz

Debit de lucru 4 l/min. Granulometrie max. 0,5mm

Presiune de lucru 120 - 150 bar, vascozitate medie - mare

Dotare standard: pistol airless, duza, 15m furtun 1/4", kit reparatie, carucior

transport



BT1009127 **PAZ-7000/2 Pompa airless cu membrana pentru zugraveli/vopsitorii** 1.490

Motor electric 3.000-3.200 W alimentare 230V-50Hz

Debit de lucru 7 l/min

Duza maxima 0.042", distanta max. de pompare 90m

Presiune de lucru 210bar, vascozitate admisa medie-mare

Dotare standard: pompa, carucior, 2 pistoale, 2 furtunuri x 15m,

rezervor material din inox 20L, manometru

Poate lucra cu 2 pistoale simultan





Pompe pentru spuma poliuretanică

Cod produs

Descriere produs

Pret Euro (fara TVA)

Izolatii termice pentru subsoluri case, blocuri, mansarde, hale industriale si agricole, etc.
Izolatii fonice pentru hale industriale, apartamente, pereti case, baruri, restaurante, sali evenimente, etc.
Izolatii hidro cu poliuree pentru cuve, bazine, piscine, balcoane, acoperisuri, etc.

Nota: Pompele Bisonte FA necesita compresor minim 1.000 l/min. cu uscator. Compresorul cu uscator este necesar pentru eliminarea condensului care ar putea bloca partea pneumatica de la sistemul de pompare si totodata, pentru ca respectivul condens sa nu intre in contact cu spuma.



BT1002855 FA50 Pompa pentru spuma poliuretanică

9.933

Rata de amestec 1:1 sau 2:1, Presiune max. 200 bar
 Volum max. de lucru 9,5 kg/min.
 Lungime max. furtunuri 90 m, (se livreaza cu 15m)
 Putere echipament 10,5 kW, incalzire 6 x 1 kW,
 Incalzire furtun 3,5 kW
 Alimentare 400V, greutate 210 kg

BT0006074 Furtunuri 5 in 1 pentru pompa FA50

include 2 furtunuri material + 2 furtunuri aer si cablu electric.

BT0002848 Pistol FA50 pentru Spuma poliuretanică

BT0004040 Duza pistol 1,3 mm

BT0004141 Duza pistol 1,6 mm

BT0004142 Duza pistol 1,8 mm

BT0004143 Duza pistol 2,0 mm



1.203

1.097

30,0

34,2

34,2

34,2



BT1008030 FA60 Pompa pentru spuma poliuretanică si poliuree

11.367

Rata de amestec 1:1 sau 2:1, Presiune max. 200 bar
 Volum max. de lucru 9,5 kg/min.
 Lungime max. furtunuri 90 m (se livreaza cu 15m)
 Putere echipament 16 kW, incalzire 2 x 6 kW,
 incalzire furtun 3,0 kW
 Alimentare 400V, greutate 210 kg

BT0008351 Furtunuri 5 in 1 pentru pompa FA60

include 2 furtunuri material + 2 furtunuri aer si cablu electric.

BT0008416 Pistol FA60 pentru Spuma poliuretanică si poliuree

BT0004040 Duza pistol 1,3 mm

BT0004041 Duza pistol 1,6 mm

BT0004042 Duza pistol 1,8 mm

BT0004043 Duza pistol 2,0 mm



1.203

1.872

30,0

24,0

24,0

24,0



RT1008405 Compresor cu surub Rotair EN07 si uscator inclus - compatibil cu pompele FA50/FA60

5.789

Debit aer: 1.100 l/min.
 Presiune de lucru: 7 bar
 Rezervor aer: 270 l
 Motor electric: 7,5 kW, 400V





Accesorii pentru pompele airless

Cod produs

Descriere produs

Pret Euro (fara TVA)

Pistoale airless

BT0008570	Pistol Airless PAZ- 270, filtru interior maner (fig.1) Include duza 517; Presiune maxima 270 bar	76,3
BT0009486	Pistol PAZ-600-1/4, garda protectie inclusa, fara duza, pentru pompa PAZ81L Filet 1/4" (fig.2)	145
BT0009487	Pistol PAZ-600-3/8, garda protectie inclusa, fara duza, pentru pompa PAZ81L Filet 3/8" (fig.2)	145
BT0002028	Pistol PAZ-360, filtru interior maner (fig.3) Permite reglarea unghiului de spraiere pe verticala Include duza 517; Presiune maxima 270 bar	72,9
BT6376G500	Pistol PAZ-500B, nu necesita filtru interior maner (fig.4) Include duza 517; Presiune maxima 500 bar	66,0
BT0008827	Pistol PAZ-500, nu necesita filtru (fig.5) Include duza 535; Presiune maxima 500 bar	98,8
BT0002038	Garda de protectie duza presiune max. 345 bar	14,1



Duze airless

BT2000xxx	Duza reversibila 211, 213, 311, 313, 315, 317, 411, 511, 513, 515, 517, 519, 521, 523, 525, 527, 529, 531, 533, 535, 543	12,8
BT0002031	Garnitura pentru mufa-duza (din oțel inoxidabil + nylon)	1,9



Filtre pistol

BT3002034	Filtru verde pentru maner pistol in sistem Airless 30 micrometri	2,4
BT3002123	Filtru alb pentru maner pistol in sistem Airless 50 micrometri	2,4
BT3001994	Filtru galben pentru maner pistol in sistem Airless 100 micrometri	2,4
BT3005000	Filtru rosu pentru maner pistol in sistem Airless 150 micrometri	2,4



Extensie pentru pistoale de vopsit in sistem Airless

BT0002035	Lungime 30 cm	8,6
BT0002036	Lungime 50 cm	10,3
BT0003324	Lungime 75 cm	14,4
BT0002037	Lungime 100 cm	16,0



Cod produs

Descriere produs

Pret Euro (fara TVA)

Filtre pentru corp pompa sau aspiratie material

BT0004963	Filtru aspiratie PAZ6321/PAZ6325	8,3
BT0004978	Filtru fin aspiratie PAZ6335/PAZ6336IB filet 3/4	12,2
BTX96226	Filtru aspiratie PAZ9600	17,9
BTX98226	Filtru aspiratie PAZ9800	11,8
BT0004974	Filtru corp pompa PAZ6336IB	6,1
BT0005736	Filtru grosier aspiratie PAZ6335/PAZ6336	12,4
BT0004959	Filtru corp pompa PAZ6321/PAZ6325	6,1
BT0005739	Filtru corp pompa PAZ6335/PAZ6331	3,3
BT0008605	Filtru aspiratie model nou PAZ6860	18,3



Furtunuri de mare presiune pentru zugraveli/vopsitorii in sistem Airless

BT0008691	1/4" cu 1 m lungime, max. 270 bar	8,5
BT0002039	1/4" cu 15 m lungime, max. 280 bar	35,0
BT0009564	3/8" cu 15 m lungime, max. 280 bar	55,0
BT0002040	1/4" cu 30 m lungime, max. 280 bar	72,0
BT0009467	1/2" cu 15 m lungime, max. 220 bar	95,2
BT0005329	1/4" cu 50 m lungime	98,0
BT0004415	1/2" cu 15 m lungime, max. 310 bar, 2 straturi	105



Conectori pentru prelungire furtun cu diametru de:

BT0002041	1/4"-1/4", filet exterior-exterior	2,3
BT0005774	3/8"-3/8", filet exterior-exterior	4,3
BT0005773	1/4"- 3/8", filet exterior-exterior	3,6
BT0003326	Conector cu rotire 360 °, pentru pistol sau extensie in sistem Airless	20,0
BT0002042	Conector pivotant liber 1/4"-1/4", filet exterior-exterior, pentru furtun pompa in sistem Airless	23,3



BT0005837	Ghidaj pentru vopsire colturi	26,0
-----------	-------------------------------	------



RO0006026	Ulei pentru lubrifiere piston 240 ml	72,0
RO0009471	MF32 Ulei pentru lubrifierea pistoanelor la pompele airless 450 ml	8,2
		14,0





Slefuire pereti - tavan / Aspiratoare

Cod produs	Descriere produs	Pret Euro (fara TVA)
3533254132915	SP-3000 Slefuitor cu maner telescopic, sac si sistem colectare praf Putere motor: 800W; 230V - 50Hz Nr. rotatii disc: 800 - 1.700 rpm, diametru disc slefuire 225 mm Lungime reglabila a manerului: 140 - 180 mm Lumina de lucru Greutate: 5,8 kg	125
BT1008845	SP-3001CC Slefuitor cu maner telescopic, pad rotund si triunghiular Putere motor: 710W, 230V - 50 Hz Numar rotatii disc: 800 - 1.700 /min; 3.000 - 6.000 /min. Diametru disc slefuire: 225 mm Greutate: 3,9 kg Se livreaza in cutie de carton	155
3533254132922	SP-3001GP Slefuitor cu maner telescopic, pad rotund si triunghiular Putere motor: 710W, 230V - 50 Hz Numar rotatii disc: 800 - 1.700 /min; 3.000 - 6.000 /min. Diametru disc slefuire: 225 mm Greutate: 3,9 kg Se livreaza in cutie plastic pentru depozitare si transport	165
	Set 6 buc. granulometrie la alegere din 60/80/120/150/180/240	
BT3000xxx	Set discuri smirghel diam. 225 mm pentru SP3000 si SP3001	3,8
BT3001xxx	Set smirghel in triunghi pentru SP3001	3,8
BT300xxxx	Set discuri smirghel diam. 225mm pentru SP900 si SP901	5,7
BT300xxxx	Set smirghel in triunghi pentru SP901	5,7
	Aspiratoare de santier	
BT1005836	AS-506 Aspirator Putere motor 1,4 kW - 230V, capacitate 20+18 litri, clasa 1 insonorizare	148
6426390839893	AS-501 Aspirator Putere motor 1.6 kW - 230 , capacitate 30 l, putere aspirare >0.18 bar	278
BT1008458	AS-750 Aspirator Putere motor 0.75 kW - 230V, Volum recipient 70 l, debit aer 3.5 mc/min. Turatie reglabila 6.000 - 15.000 rpm Greutate 1.9 kg; Dimensiuni 320x230x220 mm	59,0

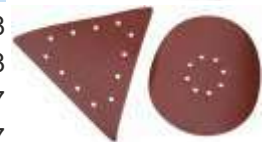



Malaxoare / Gletiere / Picioroange

Cod produs

Descriere produs

Pret Euro (fara TVA)

Malaxoare electrice

3533254132885 **M207A Mixer** pentru vopsele, 1250W, 230V



69,0

3533254132892 **M208B Mixer** pentru vopsele, 1400W, 230V, 2 viteze

91,5

3533254132908 **M210B Mixer** pentru vopsele si gleturi 1800W, 230V, 2 viteze



116

M207A
M208B

M210B

Gletiere manuale profesionale

BT0009251 WSB-20 Gletiera profesionala latime 200 mm

BT0009252 WSB-30 Gletiera profesionala latime 300 mm

BT0009253 WSB-55 Gletiera profesionala latime 550 mm

7403284154972 WSB-80 Gletiera profesionala latime 800 mm

BT0009254 WSB-120 Gletiera profesionala latime 1.200 mm



10,8

12,7

19,9

28,0

39,9



BT0009255 Maner pentru gletiera profesionala WSB 20/30/55/80/120

BT0009256 Prelungitor telescopic pentru gletiera profesionala WSB 20/30/55/80/120

10,8

16,4

Maner, prelungitor
si gletiera



Picioroange profesionale reglabile

BT0005510 Picioroange profesionale din aluminiu, reglabile de la 40-60 cm, greutate maxima admisa 100, greutate 5 kg

153

BT0005511 Picioroange profesionale din aluminiu, reglabile de la 60-100 cm, greutate maxima admisa 100, greutate 7 kg

162

BT0005509 Picioroange profesionale din aluminiu, reglabile de la 120-160 cm, greutate maxima admisa 100, greutate 10kg

223





Compressoare electrice cu piston

Cod produs

Descriere produs

Pret Euro (fara TVA)

Compressoare aer cu piston fara ulei, transmisie directa

3533254132762

SC008-009, debit aer 94 l/min., presiune operare 8 bar

119

Volum rezervor aer 9 litri;
Motor electric 230V - 0.55 kW, turatie 1480 rpm;
Greutate 16 kg;
Dimensiuni 480x150x490 mm



3533254132779

SC012-025, debit aer 168 l/min., presiune operare 8 bar

158

Volum rezervor aer 25 l;
Motor electric 230V - 0.85 kW, turatie 1480 rpm;
Greutate 23 kg;
Dimensiuni 540x260x575 mm



6426390839671

SC012-050, debit aer 168 l/min., presiune operare 8 bar

164

Volum rezervor aer 50 l;
Motor electric 230V - 0.85 kW, turatie 1480 rpm;
Greutate 25 kg;
Dimensiuni 680x320x640 mm



3533254132786

SC012-015, debit aer 168 l/min., presiune operare 8 bar

223

Volum rezervor aer 15 l;
Motor electric 230V - 0.85 kW, turatie 1480 rpm;
Greutate 23 kg;
Dimensiuni 620x420x395 mm



3533254132793

SC024-100, debit aer 336 l/min., presiune operare 8 bar

336

Volum rezervor aer 100 l;
2 motoare electrice 230V - 2 x 0.85 kW, turatie 1480 rpm;
Greutate 50 kg;
Dimensiuni 1.000x360x680 mm



3533254132809

SC020-015, debit aer 206 l/min., presiune operare 8 bar

282

Volum rezervor aer 15 l;
Motor electric 230V - 1.5 kW, turatie 1480 rpm;
Greutate 32 kg;
Dimensiuni 620x420x395 mm





Compressoare electrice cu piston

Cod produs

Descriere produs

Pret Euro (fara TVA)

Compressoare aer cu piston cu ulei, transmisie directa

3533254132816

SF020-025, debit aer 187 l/min., presiune operare 8 bar

137

Volum rezervor aer 25 l;
Motor electric 230V - 1.5 kW, turatie 2840 rpm;
Greutate 23 kg;
Dimensiuni 565x245x530 mm



3533254132823

SF020-050, debit aer 187 l/min., presiune operare 8 bar

162

Volum rezervor aer 50 l;
Motor electric 230V - 1.5 kW, turatie 2840 rpm;
Greutate 23 kg;
Dimensiuni 690x335x605 mm



3533254132830

SF020-100, debit aer 187 l/min., presiune operare 8 bar

239

Volum rezervor aer 100 l;
Motor electric 230V - 1.5 kW, turatie 2840 rpm;
Greutate 43 kg;
Dimensiuni 1.000x360x720 mm



Compresor aer cu piston cu ulei, transmisie pe curea

3533254132847

SV054-105, debit aer 786 l/min., presiune operare 8 bar

677

Volum rezervor aer 105 litri;
Motor electric 230V - 4.0 kW, turatie 1030 rpm;
Greutate 112 kg;
Dimensiuni 1.280x560x1.020 mm



3533254132854

SW102-170, debit aer 1.179 l/min., presiune operare 8 bar

790

Volum rezervor aer 170 litri;
Motor electric 230V - 7.5 kW, turatie 1050 rpm;
Greutate 160 kg;
Dimensiuni 1.530x606x1.040 mm



RO0009474 KA95 Ulei mineral aditivat pentru compresoarele de aer cu piston 1L



4,95



Aparate de sudura tip inverter

Cod produs	Descriere produs	Pret Euro (fara TVA)	
Sudura MMA			
3533254132861	MMA-160 , curent sudura 10 - 160A, electrod 1.6 - 3.2 mm Tehnologie sudura: IGBT inverter; Tensiune in gol 96V Curent nominal 160A; Tensiune nominala 26.4V; Voltaj: 230V; Putere 5.5 kW Eficienta 85%; Regim nominal 60% Greutate 5.4 kg; Dimensiuni 450x270x345 mm Echipare standard: Clesti suport electrod si masa, masca sudura si perie/ciocanel pentru zgura	144	
6426390839879	MMA-200 , curent sudura 10 - 200A, electrod 1.6 - 4 mm Tehnologie sudura: IGBT inverter; Tensiune in gol 104V Curent nominal 200A; Tensiune nominala 27.2V; Voltaj 230V; Putere 6.5 kW Eficienta 85%; Regim nominal 60% Greutate 6.0 kg; Dimensiuni 450x270x345 mm Echipare standard: Clesti suport electrod si masa, masca sudura si perie/ciocanel pentru zgura	169	
6426390839923	MMA-300-230V , curent sudura 10 - 300A, electrod 1.6 - 5 mm Tehnologie sudura: IGBT inverter; Tensiune in gol 110V Curent nominal 300A; Tensiune nominala 27.2V; Voltaj: 230V; Putere 9.5 kW Eficienta 85%; Regim nominal 60% Greutate 9.4 kg; Dimensiuni 505x270x410 mm Echipare standard: Clesti suport electrod si masa, masca sudura si perie/ciocanel pentru zgura	223	
6426390839930	MMA-300-400V , curent sudura 10 - 300A, electrod 1.6 - 5 mm Idem MMA300-230V, Tensiune nominala 29.6V; Voltaj 400V; Putere 9.5 kW	212	
Sudura TIG si MMA			
6426390839947	TIG-250 , curent sudura 15 - 250A, electrod 1 - 3 mm Tehnologie sudura: IGBT inverter de inalta tensiune; Tensiune in gol 52V Tensiune iesire 160V; Tensiune nominala 250A / 17.6V Eficienta 85%; Regim nominal 60% Plaja reglare intarziere gaz 0 - 5 secunde Factor de putere 0.7 Greutate 6.5 kg; Dimensiuni 450x270x345 mm Echipare standard: Clesti suport electrod si masa, masca sudura si perie/ciocanel pentru zgura, pistol tig complet, 2 duze ceramica si pensete	242	
6426390839954	TIG-300 , curent sudura 15 - 300A, electrod 1 - 3 mm Tehnologie sudura: IGBT inverter de inalta tensiune; Tensiune in gol 65V Curent nominal 180V; Tensiune nominala 300A; Voltaj: 400V; Putere 19.2V Eficienta 85%; Regim nominal 60% Plaja reglare intarziere gaz 0 - 5 secunde Factor de putere 0.75 Greutate 10 kg; Dimensiuni 505x270x410 mm Echipare standard: Clesti suport electrod si masa, masca sudura si perie/ciocanel pentru zgura, pistol tig complet, 2 duze ceramica si pensete	320	
Electrod sudura MMA otel carbon, pret / 1kg, comanda minima 5kg			
BT0009013	Electrod sudura E4303/J422; Ø2.5 mm, lungime 300mm, 60-85 A	4,4	
BT0009014	Electrod sudura E4303/J422 Ø3.2 mm, lungime 350 mm, 85-120 A	4,4	
BT0009015	Electrod sudura E4303/J422 Ø4.0 mm, lungime 400 mm, 115-150 A	4,4	



Taiere cu plasma

Cod produs	Descriere produs	Pret Euro (fara TVA)
6426390839961	CUT-40 , Curent iesire 10 - 40A, grosime taiere 1 - 10 mm Tehnologie inverter IGBT Voltaj 230V; Tensiune in gol 270V; Tensiune iesire 96V Eficienta 85%; Regim nominal 60%; Factor de putere 0.7 Presiune de aer recomandata 3 - 4 bar Greutate 7 kg; Dimensiuni 450x270x345 mm Echipare standard: Cablu cu cleste pentru masa; mască de sudură cu sticlă; perie și ciocănel pentru zgură; pistol CUT complet; manometru presiune; filtru aer comprimat; accesorii conectare compresor	225
6426390839978	CUT-60 , Curent iesire 10 - 60A, grosime taiere 1 - 15 mm Tehnologie inverter IGBT Voltaj 400V; Tensiune in gol 270V; Tensiune iesire 104V Eficienta 85%; Regim nominal 60%; Factor de putere 0.75 Presiune de aer recomandata 4-5 bar Greutate 11,3 kg; Dimensiuni 505x270x410 mm Echipare standard: Cablu cu cleste pentru masa; mască de sudură cu sticlă; perie și ciocănel pentru zgură; pistol CUT complet; manometru presiune; filtru aer comprimat; accesorii conectare compresor	319
6426390839985	CUT-80 , Curent iesire 20 - 75A, grosime taiere 1 - 25 mm Tehnologie inverter IGBT Voltaj 400V; Tensiune in gol 280V; Tensiune iesire 110V Presiune de aer recomandata 4-5 bar Eficienta 85%; Regim nominal 60%; Factor de putere 0.75 Greutate 21 kg; Dimensiuni 585x375x500 mm Echipare standard: Cablu cu cleste pentru masa; mască de sudură cu sticlă; perie și ciocănel pentru zgură; pistol CUT complet; manometru presiune; filtru aer comprimat; accesorii conectare compresor	504
3533254132878	CUT-100 , Curent iesire 20 - 100A, grosime taiere 1 - 40 mm Tehnologie inverter IGBT Voltaj 400V; Tensiune in gol 300V; Tensiune iesire 120V Eficienta 85%; Regim nominal 60%; Factor de putere 0.75 Presiune de aer recomandata 4-6 bar Greutate 29.2 kg; Dimensiuni 624x415x530 mm Echipare standard: Cablu cu cleste pentru masa; mască de sudură cu sticlă; perie și ciocănel pentru zgură; pistol CUT complet; manometru presiune; filtru aer comprimat; accesorii conectare compresor	664
6426390839213	CUT-120 , Curent iesire 20 - 120A, grosime taiere 1 - 45 mm Tehnologie inverter IGBT Voltaj 400V; Tensiune in gol 310V; Tensiune iesire 128V Eficienta 85%; Regim nominal 60%; Factor de putere 0.75 Presiune de aer recomandata 4-6 bar Greutate 31.5 kg; Dimensiuni 624x415x530 mm Echipare standard: Cablu cu cleste pentru masa; mască de sudură cu sticlă; perie și ciocănel pentru zgură; pistol CUT complet; manometru presiune; filtru aer comprimat; accesorii conectare compresor	786





Scari profesionale

Cod produs

Descriere produs

Pret Euro (fara TVA)

Scara simpla aluminiu

BT1006294	STR109 Scara simpla 9 trepte, 2,53 m aluminiu	66,2
BT1006295	STR111 Scara simpla 11 trepte, 3 m aluminiu	42
BT1006296	STR113 Scara simpla 13 trepte, 3,59 m aluminiu	78,7
BT1006297	STR115 Scara simpla 15 trepte, 4,13 m aluminiu	97,3

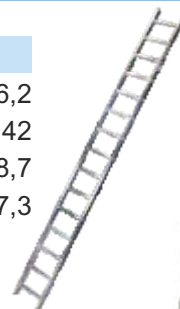

Scara dubla aluminiu

BT1006298	STR207 Scara dubla aluminiu 2x7 trepte, inaltime scara dubla 1,86 m	63,3
BT1006299	STR209 Scara dubla aluminiu 2x9 trepte, inaltime scara dubla 2,4 m	83,3
BT1006300	STR211 Scara dubla aluminiu 2x11 trepte, inaltime scara dubla 3 m	109
BT1006301	STR214 Scara dubla aluminiu 2x14 trepte, inaltime scara dubla 3,86 m	137
BT1006302	STR217 Scara dubla aluminiu 2x17 trepte, inaltime scara dubla 4,67 m	120



Scara tripla aluminiu

BT1006303	STR307 Scara tripla 7 trepte, 1,98 m aluminiu	76,9
BT1006304	STR308 Scara tripla 8 trepte, 2,25 m aluminiu	113
BT1006305	STR309 Scara tripla 9 trepte, 2,53 m aluminiu	133
BT1006306	STR311 Scara tripla 11 trepte, 3 m aluminiu	117
BT1006307	STR313 Scara tripla 13 trepte, 3,59 m aluminiu	190
BT1006308	STR315 Scara tripla 15 trepte, 4,13 m aluminiu	222



Scara multifunctionala 4 segmente

BT1006279	STR402 Scara multifunctionala din aluminiu 4 segmente x 2 trepte, 2,5 m	84
BT1006280	STR403 Scara multifunctionala din aluminiu 4 segmente x 3 trepte, 3,6 m	98,9
3533254132939	STR404 Scara multifunctionala din aluminiu 4 segmente x 4 trepte, 4,6 m	75,1
BT1006282	STR405 Scara multifunctionala din aluminiu 4 segmente x 5 trepte, 5,8 m	128



Schela cu scara dubla aluminiu

BT1006309	STR0505 Schela cu scara dubla aluminiu 1,4 m	111
BT1006310	STR0507 Schela cu scara dubla aluminiu 1,96 m	144





Scari universale si pentru interior

Cod produs	Descriere produs	Pret Euro (fara TVA)
Scara telescopica aluminiu		
BT1006283	STR1020 Scara telescopica aluminiu, 7 trepte, 2 m	46,2
BT1006284	STR1026 Scara telescopica aluminiu, 9 trepte, 2,6 m	60
3533254132953	STR1032 Scara telescopica aluminiu, 11 trepte, 3,2 m	90,7
3533254132960	STR1038 Scara telescopica aluminiu, 13 trepte, 3,8 m	106
Scara telescopica dubla aluminiu		
BT1006287	STR3032 Scara telescopica dubla aluminiu, 2x5 trepte, inaltime scara dubla 1,56 m	113
Scara aluminiu pentru interior		
BT1006288	STR0102 Scara aluminiu 2 trepte, 0,92 m pentru interior	27,8
3533254132946	STR0104 Scara aluminiu 4 trepte, 1,32 m pentru interior	38,9
BT1006290	STR0106 Scara aluminiu 6 trepte, 1,7 m pentru interior	57,3
Scara otel pentru interior		
BT1006291	STR0202 Scara otel 2 trepte, 52 cm pentru interior	27,3
BT1009010	STR0203 Scara otel 3 trepte, pentru interior	25,6
BT1006292	STR0204 Scara otel 4 trepte, 104 cm pentru interior	44,0
BT1006293	STR0206 Scara otel 6 trepte, 156 cm pentru interior	55,1





Betoniere semi-profesionale / Roabe

Cod produs	Descriere produs	Pret Euro (fara TVA)
7403284154996	BBY 120 Betoniera Bisonte. Motor electric: 0,375 kW, capacitate cuva brut: 120l, greutate echipament: 45 kg, viteza rotatie cuva: 36 rpm Dimensiuni ambalata (LxIxh): 810x710x380 mm Se livreaza in cutie carton (neasamblata), 6 buc. / palet	178
7403284155009	BBY 140 Betoniera Bisonte. Motor electric: 0,55 kW, capacitate cuva brut: 140l, greutate echipament: 51 kg, viteza rotatie cuva: 34 rpm Dimensiuni ambalata (LxIxh): 1.130x710x1.260 mm Se livreaza in cutie carton (neasamblata), 5 buc. / palet	188
3161304182445	BBY 160 Betoniera Bisonte. Motor electric: 0,65 kW, capacitate cuva brut: 160l, greutate echipament: 52 kg, viteza rotatie cuva: 32 rpm Dimensiuni ambalata (LxIxh): 1.170x710x1.380 mm Se livreaza in cutie carton (neasamblata), 5 buc. / palet	195
7403284155016	BBY 180 Betoniera Bisonte. Motor electric: 0,8 kW, capacitate cuva brut: 180l, greutate echipament: 55 kg, viteza rotatie cuva: 32 rpm Dimensiuni ambalata (LxIxh): 840x730x1.390 mm Se livreaza in cutie carton (neasamblata), 5 buc. / palet	204
3161304182452	BBY 200 Betoniera Bisonte. Motor electric: 0,8 kW, capacitate cuva brut: 200l, greutate echipament: 58 kg, viteza rotatie cuva: 30 rpm Dimensiuni ambalata (LxIxh): 1.190x730x1.410 mm Se livreaza in cutie carton (neasamblata), 5 buc. / palet	210
Accesorii si piese de schimb		
BT0007589	Curea 230J pentru BBY140 - BBY180	5,0
BT0007591	Roata 1 bucata pentru BBY140	11,0
BT0007592	Roata 1 bucata pentru BBY180	11,0
BT0007586	Cremaliera pentru BBY180	37,2
BT0007585	Cremaliera pentru BBY140	30,3
BT0008582	Cremaliera pentru BBY120	17,1
3161304182384	Clean Syntesi Acid mineral destinat curatarii betonierelor interior/exterior 0,5L	10,8
3161304182377	Clean Syntesi Acid mineral destinat curatarii betonierelor interior/exterior 1L	21,5
Roabe		
BT1009282	Roabă 70 L galvanizată , demontabilă. Grosime tabla cuva 0,75 mm Roata plina 337-7,5	25,8
BT1009283	Roabă 70 L vopsita , demontabilă. Grosime tabla cuva 0,5 mm Roata plina 337-7,5	25,0
BT1009284	Roabă 100 L vopsita , demontabilă. Grosime tabla cuva 0,8 mm Roata plina 337-7,5	36,5
BT1009288	Ax pentru roaba (1)	1,0
BT1009287	Camera 350-7 pentru roaba (2)	3,0
BT1009285	Roata pentru roaba cu camera, 350-7, 350mm x 70mm (3)	11,0
BT1009286	Roata plina PVC pentru roaba, 335-7.5, 335mm x 75mm (4)	4,0











Masini de carotat

Cod produs	Descriere produs	Pret Euro (fara TVA)
BT1006275	EC1500 Masina de carotat, 1.500W, diam. carota max. beton Ø80 mm Carota max. zidarie Ø200 mm / beton Ø80 mm Turatie motor in prima treapta 950 rpm, treapta 2 = 2.100 rpm Include coloana cu cremaliera Greutate echipament: 19 kg	390
BT1006276	EC2800 Masina de carotat, 2.800W, diam. carota max. beton Ø255 mm Carota max. zidarie Ø400 mm / beton Ø255 mm Turatie motor in prima treapta 500 rpm, treapta 2 = 920 rpm Include coloana cu cremaliera Greutate echipament 27 kg	985
BT1006277	EC3000 Masina de carotat, 2.800W, diam. carota max. beton Ø300 mm Carota max. zidarie Ø500 mm / beton Ø300 mm Turatie motor in prima treapta 500 rpm, treapta 2 = 920 rpm Include coloana cu cremaliera Greutate echipament: 27,3 kg	1.070
BT2000545	Carota diamantata 42x400 mm prindere 1 ¼" UNC	22,9
BT2000546	Carota diamantata 50x400 mm prindere 1 ¼" UNC	25,6
BT2007212	Carota diamantata 83x400 mm prindere 1 ¼" UNC	38,7
BT2000547	Carota diamantata 102x400 mm prindere 1 ¼" UNC	51,0
BT2008788	Carota diamantata 112x400 mm prindere 1 ¼" UNC	56,3
BT2000548	Carota diamantata 120x400 mm prindere 1 ¼" UNC	52,5
BT2000549	Carota diamantata 127x400 mm prindere 1 ¼" UNC	62,8
BT2000550	Carota diamantata 132x400 mm prindere 1 ¼" UNC	68,3
BT2000559	Carota diamantata 152x400 mm prindere 1 ¼" UNC	77,2
BT2000560	Carota diamantata 159x400 mm prindere 1 ¼" UNC	81,4
BT2000561	Carota diamantata 166x400 mm prindere 1 ¼" UNC	84,3
BT2000562	Carota diamantata 180x400 mm prindere 1 ¼" UNC	94,2
BT2000551	Carota diamantata 202x400 mm prindere 1 ¼" UNC	134
BT2000552	Carota diamantata 254x400 mm prindere 1 ¼" UNC	190
BT2000553	Carota diamantata 300x400 mm prindere 1 ¼" UNC	243
BT2000554	Carota diamantata 350x400 mm prindere 1 ¼" UNC	291
BT2000555	Carota diamantata 400x400 mm prindere 1 ¼" UNC	433
BT2000556	Carota diamantata 450x400 mm prindere 1 ¼" UNC	560
BT2000557	Carota diamantata 500x400 mm prindere 1 ¼" UNC	629





Generatoare de curent OPEN

Cod produs	Descriere produs	Pret Euro (fara TVA)	
7403284155023	SK2500 Putere max. 2,2kW, 230V-50Hz, AVR, Motor benzina 7 cp Rezervor carburant 15L; Autonomie 11 ore - 100% consum Contor ore/voltmetru/frecventa; Senzor lipsa ulei cu led rosu si oprire motor; Demaraj la sfoara Greutate: 41,3kg; Dimensiuni: 589x438x450 mm	251	
7403284155030	SK2800 Putere max. 2,8kW, 230V-50Hz, AVR, Motor benzina 7 cp Rezervor carburant 15L; Autonomie 10 ore - 100% consum Contor ore/voltmetru/frecventa; Senzor lipsa ulei cu led rosu si oprire motor; Demaraj la sfoara Greutate: 41,7kg; Dimensiuni: 589x438x450 mm	256	
7403284155047	SK4500 Putere max. 3,8kW, 230V-50Hz, AVR, Motor benzina 7,5 cp Rezervor carburant 15L; Autonomie 8 ore - 100% consum Contor ore/voltmetru/frecventa; Senzor lipsa ulei cu led rosu si oprire motor; Demaraj la sfoara Greutate: 46,5kg; Dimensiuni: 589x438x450 mm	314	
7403284155054	SK5000E Putere max. 4,8kW, 230V-50Hz, AVR, Motor benzina 14 cp Rezervor carburant 25L; Autonomie 7,5 ore - 100% consum Contor ore/voltmetru/frecventa; Senzor lipsa ulei cu led rosu si oprire motor; Demaraj electric Roti si manere pentru transport incluse Greutate: 76,5kg; Dimensiuni: 683x515x545 mm	528	
7403284155061	SK5500E Putere max. 5,5kW, 230V-50Hz, AVR, Motor benzina 14 cp Rezervor carburant 25L; Autonomie 7 ore - 100% consum Contor ore/voltmetru/frecventa; Senzor lipsa ulei cu led rosu si oprire motor; Demaraj electric Roti si manere pentru transport incluse Greutate: 80,3kg; Dimensiuni: 683x515x545 mm	534	
7403284155078	SK10000E Putere max. 8kW, 230V-50Hz, AVR, Motor benzina 16 cp Rezervor carburant 25L; Autonomie 5 ore - 100% consum Contor ore/voltmetru/frecventa; Senzor lipsa ulei cu led rosu si oprire motor; Demaraj electric Roti si manere pentru transport incluse Greutate: 89,7kg; Dimensiuni: 683x515x545 mm	655	
BT0004370	Ulei motor pe benzina, Italia Star 10W-40 fabricat in Romania, bidon 1L	5,4	

BISONTE AGRO



Motocultoare
Pagina 49



Masini multifunctionale
Pagina 52



Remorci pentru motocultoare
Pagina 54



Motoburghie
Pagina 54



Trenchere (sapare santuri)
Pagina 54



Motopompe si furtunuri absorbție
Pagina 55



Masini si tractoare de tuns iarba
Pagina 57



Atomizoare
Pagina 58



Aparate de spalat cu presiune
Pagina 58



Despicatoare lemne
Pagina 59









Tocatoare crengi
Pagina 59





Motocultoare

Cod produs	Descriere produs	Pret Euro (fara TVA)	
BT6000026	Motosapa BTA-MT430Y motor in 2 timpi 1,8 CP, 42.7 cmc, 8.000 rpm, latime lucru 235mm. Demaror cu recul, aprindere cu scanteie, ambreiaj centrifugal Raport benzina/ulei 40:1. Raport transmisie 32:1 Greutate netă 18,2 kg, dim. ambalaj: 540 x 300 x 550 mm	200	
3161304182339	Motocultor BTA-750 fara cover, motor 170F 212 cmc, benzina, 7CP, transmisie curea, corp aluminiu, roti 4.00-8 SET LIVRARE 2 x Roată de cauciuc 4.00-8 / 40 cm 1 x Set două freze segmentabile 30 cm, 2+1 1 x Suport fix pentru accesorii 1 x Tijă reglare adâncime 2 x Manicot (tub hexagonal) Ø23 mm, 4 găuri Greutate bruta 79 Kg, dim. ambalaj 740x420x825mm	342	
7403284155146	Motocultor BTA-750-1 (cover) Idem	La cerere	
BT6000042	Motocultor BTA-750FR (fara roti) Idem	La cerere	
7403284155153	Motocultor BTA-900 cover, motor 170F 212 cmc, benzina, 7CP, transmisie curea, corp fonta, roti 5.00-8 SET LIVRARE 2 x Roată de cauciuc 5.00-8 / 40 cm 1 x Set două freze segmentabile 30 cm, 2+1 1 x Suport fix pentru accesorii 1 x Tijă reglare adâncime 2 x Manicot (tub hexagonal) Ø23 mm, 4 găuri Greutate bruta 93 Kg, dim. ambalaj 740x420x825mm	427	
BT6000043	Motocultor BTA-900FC (fara cover) Idem	La cerere	
7403284155092	Motocultor BTA-1000 cover, motor 170F 212 cmc, benzina, 7CP, cutie de viteze, corp fonta, roti 5.00-8 SET LIVRARE 2 x Roată de cauciuc 5.00-8 / 40 cm 1 x Set două freze segmentabile 30 cm, 2+1 1 x Suport fix pentru accesorii 1 x Tijă reglare adâncime 2 x Manicot (tub hexagonal) Ø23 mm, 4 găuri Greutate bruta 89 Kg, dim. ambalaj 840x550x655mm	435	
BT6000044	Motocultor BTA-1000FC (fara cover) Idem	411	
BT6000057	Motocultor BTA-1000FC-HLS (fara cover) Idem. Dotat cu reductor.	480	
			
BT6000056	Motocultor BTA-1000FC-DIF (fara cover) Idem. Dotat cu diferential si reductor	540	
			



Motocultoare

Cod
produs

Descriere produs

Pret Euro
(fara TVA)

7403284155108 **Motocultor BTA-10SG** cover, motor 177F 300 cmc, benzina, 10CP, 559

cutie de viteze, corp fonta, roti 5.00-12
SET LIVRARE
2 x Roată de cauciuc 5.00-12
1 x Set două freze segmentabile 30 cm, 2+2+1
1 x Suport fix pentru accesorii
1 x Tijă reglare adâncime
2 x Manicot (tub hexagonal) Φ 32 mm, 4 găuri
Greutate bruta 140 Kg, dim. ambalaj 1.075x570x840mm



BT6000009 **Motocultor BTA-13SG** cover, motor 188F 389 cmc, benzina, 13CP, 685

cutie de viteze, corp fonta, roti 5.00-12
SET LIVRARE
2 x Roată de cauciuc 5.00-12
1 x Set două freze segmentabile 30 cm, 2+2+1
1 x Suport fix pentru accesorii
1 x Tijă reglare adâncime
2 x Manicot (tub hexagonal) Φ 32 mm, 4 găuri
Greutate bruta 145 Kg, dim. ambalaj 1.075x570x840mm



BT6000010 **Motocultor BTA-16SG** cover, motor 190F 420 cmc, benzina, 16CP, 725

cutie de viteze, corp fonta, roti 5.00-12
SET LIVRARE
2 x Roată de cauciuc 5.00-12
1 x Set două freze segmentabile 30 cm, 2+2+1
1 x Suport fix pentru accesorii
1 x Tijă reglare adâncime
2 x Manicot (tub hexagonal) Φ 32 mm, 4 găuri
Greutate bruta 150 Kg, dim. ambalaj 1.075x570x840mm



BT6000011 **Motocultor BTA-16SGE** cover, motor 190F 420 cmc, benzina, 16CP, 881

cutie de viteze, corp fonta, roti 5.00-12, demaror electric cu pornire la cheie -
baterie inclusa
SET LIVRARE
2 x Roată de cauciuc 5.00-12
1 x Set două freze segmentabile 30 cm, 2+2+1
1 x Suport fix pentru accesorii
1 x Tijă reglare adâncime
2 x Manicot (tub hexagonal) Φ 32 mm, 4 găuri
Greutate bruta 150 Kg, dim. ambalaj 1.075x570x840mm



7403284155115 **Motocultor BTA-12SDE** cover, motor SC188F 438 cmc, diesel, 12CP, 1039

cutie de viteze, corp fonta, roti 5.00-12, demaror electric cu pornire la cheie -
baterie inclusa
SET LIVRARE
2 x Roată de cauciuc 5.00-12
1 x Set două freze segmentabile 30 cm, 2+2+1
1 x Suport fix pentru accesorii
1 x Tijă reglare adâncime
2 x Manicot (tub hexagonal) Φ 32 mm, 4 găuri
Greutate bruta 180 Kg, dim. ambalaj 1.075x570x840mm





Accesorii motocultoare

Cod produs	Descriere produs	Pret Euro (fara TVA)
BT7000114	Plug arat simplu (1)	28,1
BT7000115	Plug bilonat ajustabil (2)	39,2
BT7000116	Plug scos cartofi (3)	30,9
BT7000122	Plug arat reversibil mare (4)	126
BT7000117	Bilonator (5)	26
BT7000118	Roata metalica 4.00-8 (6)	43,3
BT7000119	Roata metalica 5.00-12 (7)	68
BT7000120	Tub hexagonal 23 mm (8)	4,5
BT7000121	Tub hexagonal 32 mm (9)	6
BT7000123	Freza completa 23 mm (10)	82,2
BT7000124	Freza completa 32 mm (11)	148
BT7000125	Cutit stanga 23 mm (12)	2,4
BT7000126	Cutit dreapta 23 mm (12)	2,4
BT7000129	Limitator adancime (13)	9,3
BT7000130	Suport pentru accesorii (14)	11,2
BT7000131	Roata cauciuc 4.00-8 (15)	16,8
BT7000132	Roata cauciuc 5.00-8 (15)	23
BT7000133	Roata cauciuc 5.00-12 (15)	42,4
BT7000134	Camera 4.00-8 (16)	2
BT7000135	Camera 5.00-8 (16)	4,7
BT7000136	Camera 5.00-12 (16)	4,5
BT7000137	Anvelopa 4.00-8 (17)	10,3
BT7000138	Anvelopa 5.00-8 (17)	15
BT7000139	Anvelopa 5.00-12 (17)	28
BT7000140	Bolt cu siguranta 8 x 45 mm (18)	0,2
BT0002384	Contor ore functionare motor benzina 4 timp	15,4
BT0004370	Ulei motor pe benzina, Italia Star 10W-40, fabricat in Romania	5,4
BT0009179	Ulei transmisie	5,0

Cod produs

Descriere produs

Pret Euro (fara TVA)

BT6000027 BTA-MF360 Multifunctional, motor Loncin G200F 6,5 CP

784

Monocilindric, 4 timpi, răcit cu aer.

Alimentare cu benzină fără plumb. Capacitate rezervor combustibil 3,6 l, ulei motor 0,6 l.

Demaror manual. Cutie de viteze cu priză de putere.

2 viteze înainte + 2 viteze înapoi.

Dimensiune roți 6.00-8

Recomandat pentru suprafețe între 2.000 și 10.000mp

Set livrare - Multifuncțional fără accesorii.



ACCESORII Multifuncțional BTA-MF360

BT7000494 **Freză BTA-TI360**. Lățime de lucru 620 mm. Adâncime 200 mm (1)

353

BT7000495 **Sistem cosire BTA-GC360**. Lățime de lucru 970 mm. Înălțime tăiere 20-60 mm (2)

402

BT7000496 **Dispozitiv măturat BTA-SW360**. Lățime lucru 900mm. Ajustare înălțime 0-50 mm (3)

481

BT7000497 **Plug zăpadă BTA-DB360**. Lățime de lucru 850 mm. Ajustare înălțime 0-50 mm (4)

231

BT7000498 **Freză zăpadă BTA-ST360**. Lățime de lucru 560 mm. Distanța de aruncare 6m (5)

384

BT7000499 **Set roți metalice și plug BTA-SP360**. Distanță exterioară roți 420mm (6)

132

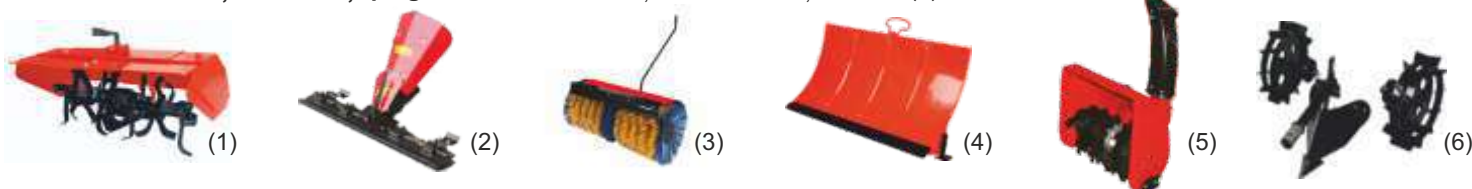

BT6000028 BTA-MF400 Multifunctional, motor Dingking 15 CP

1343

Monocilindric, 4 timpi, răcit cu aer.

Alimentare cu benzină fără plumb. Capacitate rezervor combustibil 6 l, ulei motor 1,1 l.

Demaror manual. Cutie de viteze cu priză de putere.

3 viteze înainte + 3 viteze înapoi.

Dimensiune roți 5.00-10

Recomandat pentru suprafețe între 2.000 și 20.000mp

Set livrare - Multifuncțional fără accesorii.



ACCESORII Multifuncțional BTA-MF400

BT7000500 **Freză BTA-TI400**. Lățime de lucru 800 mm. Adâncime 200 mm (1)

379

BT7000501 **Sistem cosire BTA-GC400**. Lățime de lucru 1.200mm.

465

Înălțime tăiere 20-60 mm (2)

BT7000502 **Dispozitiv măturat BTA-SW400**. Lățime de lucru 1.100 mm (3)

777

BT7000503 **Plug zăpadă BTA-DB400**. Lățime de lucru 920 mm (4)

302

BT7000504 **Freză zăpadă BTA-ST400**. Lățime de lucru 720 mm (5)

490

BT7000505 **Plug bilonat BTA-SP400** (6)

120

BT7000506 **Plug arat BTA-PL400** (7)

138

BT7000507 **Roți metalice BTA-MW500** (8)

98

BT7000508 **Greutăți roți** (9)

151

BT7000509 **Roți duble cauciuc** (10)

172





Motocultoare / Masini multifunctionale / Accesorii Motorizare HONDA

Cod produs	Descriere produs	Pret Euro (fara TVA)
BTA-FLASH150H	Motocultor BTA-FLASH150H fara cover, motor HONDA GX200, 196 cmc, benzina, 6,5 CP, transmisie curea, roti 4.00-8 SET LIVRARE 2 x Roată de cauciuc 4.00-8 / 40 cm 1 x Set două freze segmentabile, 2+1 1 x Tijă reglare adâncime 2 x Manicot (tub rotund) Greutate neta 55 Kg	774 HONDA
BTA-FLASH250H	Motocultor BTA-FLASH250H cover, motor HONDA GX200 196 cmc, benzina, 6,5 CP, transmisie: cutie de viteze cu priză de putere, corp fonta, roti 4.00-8 SET LIVRARE 2 x Roată de cauciuc 4.00-8 / 40 cm 1 x Set două freze segmentabile, 2+1 1 x Suport fix pentru accesorii 1 x Tijă reglare adâncime 2 x Manicot (tub hexagonal) Φ26 mm, 4 găuri Greutate neta 85 Kg	941 HONDA
BTA-FLASH300H	Motocultor BTA-FLASH300H cover, motor HONDA GX200 196 cmc, benzina, 6,5 CP, transmisie: cutie de viteze cu priză de putere, corp fonta, roti 4.00-8 SET LIVRARE 2 x Roată de cauciuc 4.00-8 / 40 cm 1 x Set două freze segmentabile, 2+1 1 x Suport fix pentru accesorii 1 x Tijă reglare adâncime 2 x Manicot (tub hexagonal) Φ26 mm, 4 găuri Greutate neta 90 Kg	1015 HONDA
BTA-F1107X200	BTA-F1107X200 Multifunctional, motor HONDA GX200 6,5 CP Monocilindric, 4 timpi, răcit cu aer. Alimentare cu benzină fără plumb. Capacitate rezervor combustibil 3,6 l, ulei motor 0,6 l. Demaror manual. Cutie de viteze cu priză de putere. 2 viteze înainte + 2 viteze înapoi. Dimensiune roți 4.00-10 Recomandat pentru suprafețe între 2.000 și 20.000mp Set livrare - Multifuncțional fără accesorii.	1.692 HONDA
BTA-F1107X270	BTA-F1107X270 Multifunctional, Idem. Motor HONDA GX200 9 CP Capacitate rezervor combustibil 5,3 l, ulei motor 1,1 l. Roți 5.00-10	2.025 HONDA
Accesorii masini multifunctionale		
BTA-RT60F	Freză BTA-RT60F , lățime de lucru 600 mm, adâncime 200 mm (a)	679
BTA-MG1107DRY	Transmisie in ulei BTA-MG1107DRY (b)	569
BTA-FM110F	Lama cosire tip "Finger" BTA-FM110F , lățime de lucru 1.100 mm (c)	403
BTA-DM110F	Lama cosire tip "Dual Blade" BTA-DM110F , lățime de lucru 1.100 mm (d)	440





Motoburghie / Trenchere / Remorci motocultoare

Cod produs	Descriere produs	Pret Euro (fara TVA)
7403284155122	Pachet BTA-25M-ACC1 Motoburghiu 2.5 CP	154
+7403284155160 +BT7000005	Motor monocilindric in 2 timpi, benzina, 58 cc, 0 - 350 rpm, demaror la sfoara, greutate neta 10 kg, dim. ambalaj 480x390x330 mm SET LIVRARE: Motoburghiu BTA-25M, burghiu tip A 150 x 1.000 mm, burghiu tip B 200 x 1.000 mm	
7403284155139	Pachet BTA-30M-ACC2 Motoburghiu 3.0 CP	208
+7403284155160 +BT7000005 +7403284197368	Motor monocilindric in 2 timpi, benzina, 68 cc, 0 - 350 rpm, demaror la sfoara, greutate neta 10 kg, dim. ambalaj 480x410x360 mm SET LIVRARE: Burghiu 150, 200 si 250 mm	
3161304182407	Motoburghiu BTA-30M-S cu suport de lucru, (fara burghie), motor 3 cp	159
7403284155160 3533254142006 7403284197368 BT7000004 BT7000005 BT7000006 BT7000007 BT7000008 BT7000009 BT7000010	Burghiu BTA-BA150 , diametru 150, adancime 1.000 mm, tip A Burghiu BTA-BA200 , diametru 200, adancime 1.000 mm, tip A Burghiu BTA-BA250 , diametru 250, adancime 1.000 mm, tip A Burghiu BTA-BB150 , diametru 150, adancime 1.000 mm, tip B Burghiu BTA-BB200 , diametru 200, adancime 1.000 mm, tip B Burghiu BTA-BB250 , diametru 250, adancime 1.000 mm, tip B Burghiu BTA-BD150 , diametru 150, adancime 1.000 mm, tip D Burghiu BTA-BD200 , diametru 200, adancime 1.000 mm, tip D Burghiu BTA-BD250 , diametru 250, adancime 1.000 mm, tip D Arc antivibratie	23,0 29,5 37,3 26,2 28,7 26 28 32 43,8 14,4
7403284155085	BTA-450TR Masina sapat santuri (trencher) 6,5 CP , adancime max. sapare 450 mm. Ajustare adancime sapare: 150, 250, 350, 450 mm. Sapare 60 m/ora. Lanț 21 dinți. Motor monocilindric, 4 timpi, racire cu aer, benzina, demaror la sfoara. Greutate 135 Kg, dim. ambalaj 1.060x765x850mm	1.705
BT6000014	BTA-600TRE Masina sapat santuri (trencher) 15 CP , adancime max. sapare 600 mm. Ajustare adancime sapare: 200, 400, 600 mm. Sapare 60 m/ora. Lanț 27 dinți. Motor monocilindric, 4 timpi, racire cu aer, benzina, demaror electric cu pornire la cheie - baterie inclusa. Greutate 185 Kg, dim. ambalaj 1.140x765x850mm	2.073
BT6000036	BTA-500R Remorca agricola, sarcina max.500 Kg	378
BT6000020	BTA-600R Remorca agricola, sarcina max.600 Kg	496
BT7000102 BT7000103 BT7000104	Roata cauciuc 4.00-12 Anvelopa 4.00-12 Camera 4.00-12	22,2 5,8

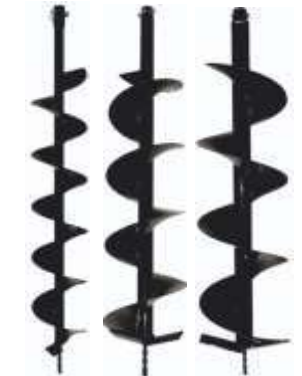
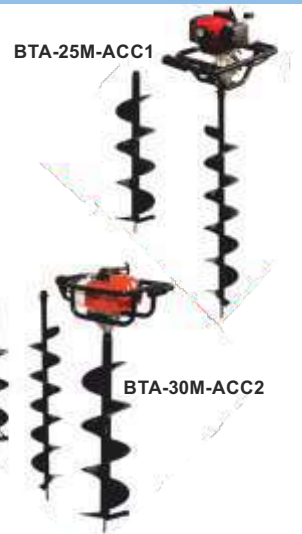



Motopompe

Cod produs	Descriere produs	Pret Euro (fara TVA)	
MOTOPOMPE APE CURATE			
BT6000029	BTA-MP25 Motopompa ape curate Ø 25 mm - 1" Debit - 4 m³/h Motor 2,5 cp-98CC, Rezervor carburant 1,35L Adancime 6 m - inaltime pompare 9m Senzor lipsa ulei cu led rosu si oprire motor. Greutate: 11kg.	133	
BT6000030	BTA-MP40 Motopompa ape curate Ø 40 mm - 1,5" Debit - 12 m³/h Motor 2,5 cp-98CC, Rezervor carburant 1,35L Adancime 6 m - inaltime pompare 25m Senzor lipsa ulei cu led rosu si oprire motor. Greutate: 12kg.	135	
MOTOPOMPE APE SEMICURATE			
BT6000031	BTA-MP50 Motopompa ape semicurate Ø 50 mm - 2" Debit - 500 l/min. Motor 7 cp-208CC, Rezervor carburant 3,6L Adancime 7 m - inaltime pompare 25m Senzor lipsa ulei cu led rosu si oprire motor. Greutate: 25kg.	168	
BT6000032	BTA-MP80 Motopompa ape semicurate Ø 80 mm - 3" Debit - 830 l/min. Motor 7 cp-208CC, Rezervor carburant 3,6L Adancime 7 m - inaltime pompare 20m Senzor lipsa ulei cu led rosu si oprire motor. Greutate: 28kg.	186	
BT6000033	BTA-MP100 Motopompa ape semicurate Ø 100 mm - 4" Debit - 1.330 l/min. Motor 7.5 cp-223CC, Rezervor carburant 3,6L Adancime 7 m - inaltime pompare 28m Senzor lipsa ulei cu led rosu si oprire motor. Greutate: 37kg.	260	
MOTOPOMPE DE PRESIUNE			
BT6000034	BTA-MPP50 Motopompa de presiune Ø 50 mm - 2" Debit - 300 l/min. H max. 80m Motor 7 cp-208CC, Rezervor carburant 3,6L Adancime 7 m - inaltime pompare 80m Senzor lipsa ulei cu led rosu si oprire motor. Greutate: 26kg.	247	
BT6000035	BTA-MPP80 Motopompa de presiune Ø 80 mm - 3" Debit - 830 l/min. H max. 70m Motor 14 cp-420CC, Rezervor carburant 6,5L Adancime 7 m - inaltime pompare 70m Senzor lipsa ulei cu led rosu si oprire motor. Greutate: 47kg.	422	

Accesorii motopompe

Cod produs

Descriere produs

Pret Euro (fara TVA)

FURTUNURI

RO0008378 **Furtun absorbție** Ø 25 mm 1" - 7 bar
 RO0008379 **Furtun absorbție** Ø 50 mm 2" - 5 bar
 RO0008380 **Furtun absorbție** Ø 75 mm 3" - 4 bar
 RO0008381 **Furtun absorbție** Ø 100 mm 4" - 4 bar

RO0009272 **Furtun refulare** Ø 25 mm 1" - 7 bar
 RO0008383 **Furtun refulare** Ø 50 mm 2" - 5 bar
 RO0008384 **Furtun refulare** Ø 75 mm 3" - 4 bar
 RO0008385 **Furtun refulare** Ø 100 mm 4" - 4 bar

RO0009273 **Furtun textil tip pompier** L 20m Ø 50 mm 2" - 10 bar Include racorduri Storz
 RO0009274 **Furtun textil tip pompier** L 20m Ø 75 mm 3" - 10 bar Include racorduri Storz
 RO0009275 **Furtun textil tip pompier** L 20m Ø 100 mm 4" - 7 bar Include racorduri Storz

*Prețurile afișate sunt pe ml. Comanda minimă este de 10 ml/multiplu de 10.



2,2
5,2
9,7
15,2



1,7
2,1
3,2
5,2



48,5
78,8
139



COLIERE SI CUPLE STORZ

218022052055 Colier pentru cupla Storz, diam. max. 55mm
 218024074079 Colier pentru cupla Storz, diam. max. 79mm
 217003051000 Cupla Storz fixa 2"-50mm
 217003076000 Cupla Storz fixa 3"-75mm
 217002051000 Cupla Storz mobila 2"-50mm
 217002076000 Cupla Storz mobila 3"-75mm

1,2
2,0
6,1
10,2
5,8
11,1





Masini si tractoare de tuns iarba

Cod produs

Descriere produs

Pret Euro (fara TVA)

MASINI DE TUNS IARBA

3161304182346 **BTA-MTG425 Masina tuns iarba autopropulsata, motor benzina 2.7CP** 201

Motor NP130 pe benzină 2.0 kW / 132 cc / 2.800 rpm

Lățime tăiere: 410 mm

Inălțime tăiere ajustabilă: 25-75 mm

Volum sac textil iarba: 45L

Dimensiuni ambalaj: 685x530x440 mm



3161304182353 **BTA-MTG450 Masina tuns iarba autopropulsata, motor benzina 3.1CP** 244

Motor NP150 pe benzină 2.3 kW / 149 cc / 2.800 rpm

Lățime tăiere: 460 mm

Inălțime tăiere ajustabilă: 25-75 mm

Volum sac textil iarba: 60L

Dimensiuni ambalaj: 815x580x530 mm



3161304182360 **BTA-MTG500 Masina tuns iarba autopropulsata, motor benzina 3.5CP** 269

Motor NP170 pe benzină 2.6 kW / 171 cc / 2.800 rpm

Lățime tăiere: 508 mm

Inălțime tăiere ajustabilă: 25-75 mm

Volum sac textil iarba: 60L

Dimensiuni ambalaj: 900x580x530 mm



TRACTOARE DE TUNS IARBA

BT6000058 **BTA-TTG630 Tractor tuns iarba, motor Loncin benzina, 7CP** 1.171

Nou!

Transmisie hidrostatica. Pornire la cheie.

Lățime tăiere: 610 mm

Inălțime tăiere ajustabilă: 35-75 mm

Volum sac textil iarba: 150L

Greutate: 113 kg

Dimensiuni: 1.480 x 760 x 830 mm



BT6000059 **BTA-TTG840 Tractor tuns iarba, motor Loncin benzina, 11CP** 1.811

Nou!

Transmisie hidrostatica. Pornire la cheie.

Lățime tăiere: 840 mm

Inălțime tăiere ajustabilă: 35-75 mm

Volum sac textil iarba: 220L

Greutate: 163 kg

Dimensiuni: 1.690 x 1.000 x 860 mm



BT6000060 **BTA-TTG1070 Tractor tuns iarba, motor Loncin benzina, 14CP** 2.240

Nou!

Transmisie hidrostatica. Pornire la cheie.

Lățime tăiere: 1.070 mm

Inălțime tăiere ajustabilă: 35-75 mm

Volum sac textil iarba: 220L

Greutate: 189 kg

Dimensiuni: 1.700 x 1.130 x 860 mm





Atomizoare Aparate de spalat cu presiune

Cod produs

Descriere produs

Pret Euro
(fara TVA)

ATOMIZOARE - PULVERIZARE UNIVERSALA

BT6000024 **Atomizor BTA-MB650Y 1,8CP** cu pompa booster inclusa, inaltime lucru 10m 148
Turație maximă: 7.000 rpm
Pulverizare universala.
Greutate netă/brută: 9 kg/10 kg. Dimensiuni ambalaj: 510x380x650 mm

BT6000025 **Atomizor BTA-MD600Y 3,4CP** cu pompa booster inclusa, inaltime lucru 12m 204
Turație maximă: 7.000 rpm. Capacitate rezervor: 14 l
Pulverizare universala - pulverizare particule solide.
Greutate netă/brută: 10,5 kg/12 kg. Dimensiuni ambalaj: 500x340x680 mm



Aparate de spalat cu presiune

3533254132977 **BT1500-A Aparat de spalat cu presiune** 66,2
Presiune max.: 120bar, motor electric: 230V, putere max.: 1.400W
Debit: 300 l/ora
Greutate: 6,5 kg, Dimensiuni LxIxh 260 x 250 x 460 mm









3533254132984 **BT1900-B Aparat de spalat cu presiune** 99,4
Presiune max.: 135bar, motor electric: 230V, putere max.: 1.800W
Debit: 360 l/ora
Greutate: 9,1 kg, Dimensiuni LxIxh 350 x 320 x 705 mm

3533254132991 **BT2350-B Aparat de spalat cu presiune** 115
Presiune max.: 160bar, motor electric: 230V, putere max.: 2.200W
Debit: 360 l/ora
Greutate: 10,2 kg, Dimensiuni LxIxh 350 x 320 x 705 mm





Despicatoare lemne / Tocate crengi

Cod produs	Descriere produs	Pret Euro (fara TVA)	
BT6000051	BTA-DO6T Despicator lemne orizontal , putere max. despicare 6 t Motor electric 2,2 kW 230V, Dimensiune bustean (L max./ Ø max.) 520 mm / 300 mm, Cursa cutit despicare 385 mm, Diametru cutit despicare 55 mm, Greutate: 67 kg, dim. ambalaj (LxlxH) 1.000x410x540 mm	396	
BT6000045	BTA-DV8T Despicator lemne vertical , putere max. despicare 8 t Motor electric 3,0 kW 230V, Dimensiune bustean (L max./ Ø max.) 650 mm / 400 mm, Cursa cutit despicare 192 mm Greutate: 102 kg, dim. ambalaj (LxlxH) 710x450x1.170 mm	685	
BT6000052	BTA-DV10TMONO Idem , putere max. despicare 10 t, 230V, greutate 108 kg	780	
BT6000053	BTA-DV12TMONO Idem , putere max. despicare 12 t, 230V, greutate 109 kg	809	
BT6000046	BTA-DV10T Despicator lemne vertical , putere max. despicare 10 t Motor electric 3,0 kW 400V, Dimensiune bustean (L max./ Ø max.) 650 mm / 500 mm, Cursa cutit despicare 192 mm Greutate: 110 kg, dim. ambalaj (LxlxH) 710x450x1.170 mm	906	
BT6000047	BTA-DV12T Despicator lemne vertical , putere max. despicare 12 t Motor electric 3,5 kW 400V, Dimensiune bustean (L max./ Ø max.) 650 mm / 500 mm, Cursa cutit despicare 192 mm Greutate: 110 kg, dim. ambalaj (LxlxH) 710x450x1.170 mm	929	
BT6000048	BTA-DV15T Despicator lemne vertical , putere max. despicare 15 t Motor electric 4,0 kW 400V, Dimensiune bustean (L max./ Ø max.) 1.100 mm / 500 mm, Cursa cutit despicare 192 mm Greutate: 183 kg, dim. ambalaj (LxlxH) 1.700x550x800 mm	1239	
BT6000049	BTA-DV18T Despicator lemne vertical , putere max. despicare 18 t Motor electric 4,0 kW 400V, Dimensiune bustean (L max./ Ø max.) 1.100 mm / 500 mm, Cursa cutit despicare 192 mm Greutate: 193 kg, dim. ambalaj (LxlxH) 1.700x550x800 mm	1336	
BT6000015	BTA-100T Tocator crengi 6,5 CP , diam. max. tocare 100 mm. Motor monocilindric, 4 timpi, racire cu aer, benzina, demaror la sfoara. Dim. roti 3.50 - 6 Greutate 85 Kg, dim. ambalaj 895x765x1.210mm	678	
BT6000016	BTA-120TE Tocator crengi 12 CP , diam. max. tocare 120 mm. Motor monocilindric, 4 timpi, racire cu aer, benzina, demaror electric cu pornire la cheie - baterie inclusa. Dim. roti 4.00 - 10 Greutate 100 Kg, dim. ambalaj 880x565x840mm	1328	

SISTEME DE POMPARE

WAGNER



Pompe airless cu membrana pentru zugravit
Pagina 61



Pompe airless cu membrana pentru vopsit
Pagina 63



Pompe airless cu piston pentru zugravit
Pagina 65



Pompe airless hidraulice pentru gleturi
Pagina 68



Pompe airless cu membrana pentru hidroizolatii si injectari
Pagina 69



Pompe pentru gleturi | tencuieli | decorative
Pagina 70

ECHIPAMENTE PENTRU FINISARE

Columbia
TAPING TOOLS



Echipamente pentru finisare gips carton
Pagina 72

ROKAMAT
Produce fabricate in Germania



Echipamente pentru slefuit, raschetat, polisat
Pagina 73



4004025129872 **SuperFinish 21 PRO HEA, SprayPack, motor 230V, 0,9 kW** 1.081



Debit material 2,1 l/min., presiune 250 bar; duza max. 0.021".

Echipare standard: furtun material DN6, max. 207 bar, pistol airless Vector Pro, garda protectie, duza HEA ProTip 517, manometru.

Materiale aplicabile: Ideala pentru aplicarea de vopsele pe bază de apă sau solventi, lacuri, emulsii si emailuri.



WA2399198 **SuperFinish 23 PRO HEA, SprayPack, motor 230V, 1,3 kW** 2.002

Debit material 2,6 l/min., presiune 250 bar; duza max. 0.023"

Echipare standard: furtun material 15m, DN6, max. 250 bar, pistol airless Vector Pro 1/4" tragaci cu 4 degete, garda protectie, duza HEA ProTip 519, manometru, cutie pentru scule

WA9984421 Furtun DN6 PN530 1/4 NPS, 10m 156.

Materiale aplicabile: Uleiuri, substraturi, grunduri, umpluturi, vopsele pe baza de rasini sintetice, vopsele acrilice, vopsele cu emulsie si latex
Recomandat pana la 800 m².



4004025081330 **SuperFinish 23 Plus HEA SprayPack, motor 230V, 1,3 kW** 2.657

Debit material 2,6 l/min., presiune 250 bar; duza max. 0.023"

Echipare standard: sistem aspiratie, PumpRunner inclus, furtun material DN6, max. 270 bar, 15m, manometru HEA, pistol airless 1/4", duza HEA 519.

Materiale aplicabile: Recomandat pana la 200 m², Vopsea pe baza de ulei, acrilica, amorse, materiale de acoperire, vopseluri acrilice pe baza de rasina, emulsii, latex.



WA2388260 **SuperFinish 33 PRO Spraypack, motor 230V, 2,2 kW** 4.274

Debit material 4,2 l/min., presiune 250 bar, duza max. 0.033"

Echipare standard: unitate de baza; sistem aspiratie flexibil, furtun material DN6, 1/4", 15m; pistol airless Vector Pro; duza TradeTip 3 523; filtru pistol alb

Materiale aplicabile: Puteti aplica o gama diversa de materiale pentru diferite dimensiuni de proiect.



WA2388259 **SuperFinish 33 PLUS Spraypack Cart, motor 230V, 2,2 kW** 4.847

Debit material 4,2 l/min., presiune 250 bar, duza max. 0.033"

Sistem de functionare in pozitie verticala si orizontala, priza 230V

Echipare standard: sistem aspiratie metalic, furtun material DN6 max. 270 bar, 15m, pistol airless 1/4", duza.

Materiale aplicabile: Uleiuri, substraturi, grunduri, umpluturi, vopsele pe baza de rasini sintetice, vopsele acrilice, vopsele emulsii, vopsele latex, agenti anticorozivi, agenti ignifugi, adezivi pentru tesaturi.

Pentru proiecte de peste 800 m².



Transforma-ti echipamentul SuperFinish 23 PLUS din aplicatii pentru zugravit in aplicatii pentru vopsit (nu include compresorul).

Kit-ul Air Coat contine:

4004025015069	Recipient pentru material 5l	72,3
4004025062933	Furtun dublu pentru material DN3 1/4" si aer DN6, 7,5 m	160
WA2368269	Pistol AirCoat include duza airless BlueAir si cap protectie	489
WA379411	Duza ACF3000 11/40	126
WA340250	Regulator AirCoat	132
Optional:		
WA2347935	Compresor AirBoost 100 , debit aer 100 l/min., motor 230V - 480W <i>in cazul utilizarii acestui compresor nu mai adauga regulatorul de mai sus</i>	1.069



WA2406208	Kit-uri zugraveli DN6 pentru PS 3.39, HC 750, HC 950, HC 970 incl.SSP Adaptor montare (F) NPSM 1/2 "la (M) NPMS 1/4" 2 x furtunuri de inalta presiune DN 6; NPSM 1/4 ", 15m (max. 27 Bar) Conector dublu 1/4 "NPSM; Pistol airless Vector Pro; Extensie duza filet G 15cm si G 30cm Duza - HEA ProTip 519 + duza - TradeTip 3 427; Recipient curatare duze TipClean 200 ml 2 chei reglabile; 10 buc. filtre albe	735
-----------	--	-----



WA2406209	Kit finisaj, materiale de umplere DN10 pentru PS 3.39, HC 750, HC 950, HC 970 incl. SSP Adaptor montare (F) NPSM 1/2 " la (M) NPMS 3/8" Furtun de inalta presiune DN 6; NPSM 3/8 ", 15m (max. 25 Bar) Conector dublu de la 3/8" NPSM la 1/4" NPSM; Pistol AG 14 (filet G); Extensie duza filet G 30cm Duza - TradeTip 3 335; Duza - TradeTip 3 439; Recipient curatare duze TipClean 200 ml 2 chei reglabile; 10 buc. filtre albe	674
-----------	---	-----



4004025099069	Kit-uri vopsitorie, lacuire DN4 pentru modelele SF 23, SF 33, SF 27, SF 31 Furtun de inalta presiune DN 4; NPSM 1/4 ", 7,5m (max. 27 Bar) Pistol airless Vector Pro; Extensie duza filet G 15cm Duza FineFinish - TradeTip 3 308 (lac); Duza FineFinish- TradeTip 3 412 (materiale de umplere) Recipient curatare duze TipClean 200 ml; Filtre rosii (10 bucati) Rezervor material 5l; M36 x 2	490
---------------	--	-----

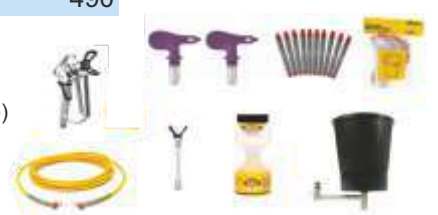

WA2406206	Kit-uri lacuire DN4 pentru modelele PS 20, PS 3.20, PS 3.21, PS 3.25 Furtun de inalta presiune DN4; NPSM; 1/4", 7,5m (max. 27 bar) Pistol airless Vector Pro; Extensie duza filet G 15cm Duza FineFinish TradeTip 3 308 (lac); Duza FineFinish TradeTip 3 412 (materiale de umplere) Recipient curatare duze TipClean 200ml; Filtre rosii (10 bucati) Rezervor material 5l; ProSpray; Filtre rezervor pentru lac	674
-----------	--	-----



WA2408212	Kit HEA DN6 pentru SuperFinish, ProSpray; PowerPainter si Impact Furtun de inalta presiune DN6; NPSM; 1/4", 15m (max. 27 bar) Pistol airless Vector Pro; Extensie duza filet G, 15 cm Duza - HEA ProTip 517; Duza - HEA ProTip 311 Recipient curatare duze TipClean 200 ml; Filtre albe (10 bucati)	490
-----------	--	-----



4004025098598	TipClean - Recipient 200 ml tip clepsidra cu solutie pentru curatarea duzelor airless Wagner	18,5
---------------	---	------



Cod produs	Descriere produs	Pret Euro (fara TVA)	
4004025129889	SuperFinish 21 LACQ , motor 230V, 0,9 kW Debit material 2,1 l/min., presiune max. 207 bar; Duza max. 0.021" Echipare standard: unitate de baza, recipient material 5 l, furtun material DN3, manometru; Pistol Vector Pro; Duza TradeTip 3 FineFinish 410	1.274	
WA311061	Finish 230 Enamel Spraypack skid , motor 230V, 1,1 kW Debit material 1,25 l/min., presiune max. 260 bar; Duza max. 0.019" Echipare standard: furtun material DN4, 270 bar, 4", 7,5 m; Pistol Airless Pro 1/4"; Duza reversibila dubla L10, 208/510; Filtru pistol rosu 180MA, recipient material 5 l	1.420	
			LICHIDARE STOC
WA2341492	SuperFinish 23 Plus Enamel Spraypack cart , motor 230V, 1,3 kW Debit material 2,6 l/min., presiune 250 bar; Duza max. 0.023" Echipare standard: furtun material DN 3, max. 270 bar, 7,5 m; pistol airless 1/4"; Duza dubla reversibila L10, 208/510; Filtru pistol 180 MA	2.639	
WA2341496	SuperFinish 23 Plus TempSpray Spraypack cart , motor 230V, 1,3 kW Debit material 2,6 l/min., presiune 250 bar; Duza max. 0.023" Echipare standard: Unitate de baza; recipient material 5 l; TempSpray H126; pistol airless Vector grip; Duza dubla L10, 208/510; Filtru pistol rosu extra fin	4.240	
WA2353393	SuperFinish 23 Plus AirCoat Enamel Spraypack , motor 230V, 1,3 kW Debit material 2,6 l/min., presiune max. 250 bar; Duza max. 0.023" Echipare standard: unitate de baza; furtun dublu 1/4", 10m; material DN4, aer DN6; Pistol AirCoat AC 4600 Professional; duza airless ACF3000 11/40 verde; Compresor AirBoost 100; regulator AirCoat, kit fittinguri.	4.235	
Temp Spray furtun incalzit (20-60°C) pentru material, asigura o mai buna vascozitate			
4004025065712	TempSpray H126 BasicUnit 0,6kW si 10m furtun (nu include pistolul)	1.907	
WA2311660	TempSpray H226 BasicUnit 1,1kW si 15m furtun, tambur inclus (nu include pistolul)	2.735 1274	

Cod produs

Descriere produs

Pret Euro (fara TVA)

Transforma-ti echipamentul SuperFinish 23 PLUS din aplicatii pentru vopsit in aplicatii pentru zugravit.

Kit-ul Spray Pack include:

Cod produs	Descriere produs	Pret Euro (fara TVA)
WA2342879	Sistem aspirare, PumpRunner inclus	195
WA9984574	Furtun 15m, 1/4", 270 bar	142
024964240555	Pistol airless Vector Grip, 1/4", include garda protectie duza	269
WA271045	Duza dubla D10, 111/419	45,7



Kit-ul HEA include:

Cod produs	Descriere produs	Pret Euro (fara TVA)
WA2342879	Sistem aspirare, PumpRunner inclus	195
WA9984574	Furtun 15m, 1/4", 270 bar	142
WA2383995	Manometru presiune HEA	72,3
024964240555	Pistol Airless Vector Grip, 1/4", include garda protectie duza T	269
024964271009	Duza HEA 519	43,4



Furtunuri duble AirCoat

Cod produs	Descriere produs	Pret Euro (fara TVA)
WA9984596	HP furtun dublu material DN3, max. 270 bar, aer DN6, 1/4", 10m	160
4004025062933	HP furtun dublu material DN3, max. 270 bar, aer DN6, 1/4", 7,5 m	164
WA2306802	HP furtun dublu material DN3, max. 270 bar, aer DN6, M16x1,5, 7,5 m	140
4004025063350	HP furtun dublu material DN4, max. 270 bar, aer DN6, 1/4", 10 m	178
WA2302378	HP furtun dublu material DN4, max. 270 bar, aer DN6, 1/4", 7,5 m	140
WA2306803	HP furtun dublu material DN4, max. 270 bar, aer DN6, M16x1,5, 7,5 m	140



Pistoale AirCoat AC4500 si AC4600 Profesional, speciale pentru vopsitorie fina, intrare separata material si aer (nu include duza)

Cod produs	Descriere produs	Pret Euro (fara TVA)
4004025114571	AC4600 Profesional, cap BlueAir (vopsea baza apa) si garda protectie	606
WA394157	AC4600 Profesional, cap RedAir (vopsea baza solvent si apa) si garda	607
WA394158	AC4600 Profesional, cap GreenAir (vopsea baza solvent) si garda protectie	607
WA2368269	AC4500 Profesional, cap BlueAir (vopsea baza apa) si garda protectie	489
WA2368270	AC4500 Profesional, cap RedAir (vopsea baza solvent si apa) si garda	427
WA2368271	AC4500 Profesional, cap GreenAir (vopsea baza solvent) si garda protectie	501
WA379XXX	Duze AirCoat ACF3000	126



Cod produs	Descriere produs	Pret Euro (fără T.V.A.)
------------	------------------	-------------------------

4004025130397 **Finish Control 4000, Pulverizator electric XVLP** 653



Putere motor 0,37 kW, 0,2 bar
Volum recipient material 1.000 ml.
Greutate cu si fara bateria 1,9 / 1,3 kg



4004025130045 **Finish Control 4000, Pulverizator electric XVLP (fara acumulator)** 485

WA2454464 Set 4 filtre aer pentru Wagner Finish Control 4000 18V 12,8



4004025079931 Adaptor HVLP pentru cutia de vopsea Wagner Finish Control 4000 18V 36,7



4004025128486 Rezervor din plastic pentru **Finish Control 4000** 84,9

4004025128448 **FinishControl 5500, Echipament HVLP/XVLP** 627



Putere motor 1,15 kW, 0,29 bar, Presiune de lucru 0,29 bar, Putere motor 1,15 kW, Demaraj Electric, Greutate 6,6 kg



4004025129964 **FineCoat 9700 L, Pulverizator electric XVLP/HVLP** 669



Putere motor 1.15 kW, 0,3 bar
Volum recipient material 1.000 ml. Furtun aer 7,6 m. Cablu electric 4 m.
Greutate 6,8 kg



004025086670 **ControlMax® 1900 PRO Skid Pompa airless cu piston, debit material** 652



1,5l/min., duza max. 0.019", motor electric 0,6 kW



4004025086717 **ControlMax® 1900 PRO Cart Pompa airless cu piston, debit material** 762



1,5l/min., duza max. 0.019", motor electric 0,6 kW



Echipe standard **ControlMax® 1900 PRO Skid/Cart:**

Pistol airless HEA
Duza HEA 517
15 m furtun airless



- Suport durabil din otel cu maner telescopic
- Sureflo™ Valva amorsare – Usor si rapid de fiecare data
- Buton ON/OFF Control presiune
- Pistol cu maner confortabil si tragaci cu apasare usoara
- Filtru vopsea – previne infundarea pompei

WA2414079 **PowerPainter 90 Extra HEA Spraypack skid, motor 230V, 0,8 kW** 1.062



Debit material 1,3 l/min., presiune 207 bar; Duza max. 0.019"
Echipe standard: furtun material DN6, max. 270 bar, aer 1/4"- 15m
Pistol Vector Pro 1/4", duza HEA 517, manometru



4004025098673 **PowerPainter 90 Extra Cart Idem** 989

Set recipient 5L pentru PP90

4004025127083 Kit reparatie sectiune fluid + valva aspiratie Wagner 146

4004025068614 pentru pompa airless PP90 195



4004025131592 **SprayPack 18V - Pulverizator hibrid unic, airless, care poate fi folosit ca** 820



rusnac, staționar sau transport lateral.

Debit material 0.9 l/min., presiune 110 bar; Duza max. 0.017"; Volum rezervor material 4,7 l; Lungime max. furtun 7,5 m; Greutate 5,5 kg



4004025126116 **ProSpray 3.20 HEA Spraypack skid, motor 230V, 1kW** 1.658

Debit material 1,6 l/min., presiune 207 bar; Duza max. 0.021"

Echipare standard: furtun material DN6, max. 270 bar, aer 1/4"- 15m

Pistol Vector Pro 1/4", duza HEA 517, manometru



WA532089 **ProSpray 3.21 HEA Spraypack skid, motor 230V, 1,03kW** 2.714

Debit material 2 l/min., presiune 221 bar; Duza max. 0.023", modul inteligent pentru comanda si control

Echipare standard: furtun material DN6, max. 270 bar, aer 1/4"- 15m

Pistol Vector Pro 1/4", duza HEA 517, manometru, rezervor lubrifiere



WA2308260 **ProSpray 3.25 Spraypack cart, motor 230V, 1,1kW** 3.608

Debit material 2,6 l/min., presiune 221 bar; Duza max. 0.027";

Echipare standard: furtun material DN6, max. 270 bar, aer 1/4"- 15m

Pistol Vector Grip 1/4", duza dubla 111/419, rezervor lubrifiere



WA2308262 **ProSpray 3.31 SprayPack cart, motor 230V, 1.84 kW** 5.439

Debit material 3.8 l/min., presiune 221 bar; Duza max. 0.032";

Echipare standard: unitate de baza; furtun DN6, 1/4", 15m; pistol airless

Vector Grip; garda protectie duza; Duza dubla D20, 115/421



2351261 **ProSpray 3.39 SprayPack cart, motor 230V, 2,19 kW** 6.516

Debit material 5,0 l/min., presiune 221 bar; Duza max. 0.039";

Echipare standard: unitate de baza; furtun DN6, 1/4", 15m; pistol airless

Vector Grip; garda protectie duza; Duza HEA 519; Conector dublu A = 1/4"

NPS x 3/8" NPT; Conector dublu A = 3/8" NPT x A = 1/2" NPS



SprayRoller pentru conectare cu pompa airless

WA2411697 **SprayRoller cadru 25 cm, include SpeedShield** 267

Include: Sprayroller 25cm; duza TT3 415; SpeedShield; conector pivotant



4004025084676 **SprayRoller carcasa 23 cm cu SpeedShield** 489

Include: Sprayroller 25cm; duza TT3 415; SpeedShield; conector pivotant



WA2418370 **Roller cu alimentare din interior** 60,0

Include: Roller cu alimentare din interior si rola



Accesorii si piese de schimb

WA0998230 Rola 12 mm grosime 5,2

WA0245717 Rola 20 mm grosime 6,0

WA2325720 Manseta roller pentru distribuirea uniforma a materialului 6,0

WA509907 Adaptor 90° 80

WA2420538 Extensie ranforsata pentru rola 0,9 m 106

Cod produs	Descriere produs	Pret Euro (fara TVA)
Pachet duza + filtru		
WA553XXX	Duza 315 / 415 / 515 TradeTip 3, cu filtru galben pentru pistol inclus	26,1
WA553XXX	Duza 417 / 419 / 421 / 423 TradeTip 3, cu filtru alb pentru pistol inclus	26,1
WA553XXX	Duza 517 / 519 / 521 / 523 / 525 TradeTip 3, cu filtru alb pentru pistol inclus	26,1
WA553643	Duza 643 TradeTip 3, cu filtru verde pentru pistol inclus	26,1
WA554XXX	Duza 415 / 417 / 517 / 519 / 521 HEA ProTip	43,4
WA554XXX	Duza 410 / 510 / 412 / 512 pentru solventi / vopsea	43,4
WA271XXX	Duza dubla 111 / 419	45,7



(Nou!) Extensii si conectori

WA2418853	Extensie pistol airless 12,5 cm	35,7
WA0556075	Extensie pistol airless 30 cm	40,1
024964301027	Extensie pistol airless 50 cm	49,1
WA2418856	Extensie pistol airless 75 cm	58,0
WA2418862	Extensie pistol airless 90 cm	115
4004025013430	Extensie pistol airless 100 cm	192
WA2418863	Extensie pistol airless 180 cm	178
4004025130564	Cot reglabil 360 (int/ext 1/4")	99,9
4004025130571	Conector reglabil 360 (int/ext 1/4")	27,9
4004025130588	Conector reglabil 360 (int/ext 3/8")	27,9



Pistoale airless

4004025084928	Pistol airless Vector Pro, 250 bar, 1/4" include garda protectie TradeTip3, tragaci full pentru 4 degete	207
4004025084935	Pistol airless Vector Pro, 250 bar, 1/4" include garda protectie TradeTip3, tragaci ergonomic pentru 2 degete	207
024964240555	Pistol airless Vector Grip, 250 bar, 1/4" include garda protectie TradeTip3, tragaci cu 2 sau 4 degete	269
024964273799	Pistol Vector Infinity, 345 bar, filet G 1/4", include garda protectie TradeTip3, tragaci ergonomic cu 2 degete	421
024964206612	Pistol AG14, 270 bar, filet G 1/4", include garda protectie TradeTip3	273
WA502166	Pistol AG14, 270 bar, filet F 1/4", include garda protectie TradeTip3	280
4004025077050	Pistol AG19, 250 bar, filet G 3/8", include garda protectie TradeTip3	355
WA2343778	Pistol AG19 530 bar, 1/4", include garda protectie TradeTip3	403



Furtunuri material

WA9984583	Furtun material DN3, 270 bar, NPS 1/4", 7,5 m	79,6
WA2302374	Furtun material DN4, 270 bar, NPS 1/4", 10 m	107
WA9984573	Furtun material DN4, 270 bar, NPS 1/4", 7,5 m	88,6
WA9984574	Furtun material DN6, 270 bar, NPSM 1/4", 15 m	142
WA9984575	Furtun material DN6, 270 bar, NPSM 1/4", 30 m	268
WA2336583	Furtun material DN10, max. 250 bar, NPSM 3/8", 15 m	196
WA2336584	Furtun material DN10, max. 250 bar, NPSM 3/8", 30 m	312
WA2336585	Furtun material DN13, max. 250 bar, 3/8", NPSM 1/2", 15 m	339
WA2336586	Furtun material DN19, max. 250 bar, NPSM 3/4", 15 m	655
WA9984421	Furtun DN6 PN530 1/4 NPS, 10m, pentru SuperFinish 23 Pro HEA	156



Cod produs	Descriere produs	Pret Euro (fara TVA)
	Pompa electrica cu actionarea pistonului de catre grup hidraulic	
WA2371027	HeavyCoat 750E Spraypack , motor 230V, 3,1 kW Debit material 6 l/min., presiune 250 bar Duza max. 0.043" Echipare standard: unitate de baza; furtun material DN13, 3/8", NPSM 1/2", 15m; furtun pentru manevrare DN10, 3/8", 2,5m, conector 3/8" x 1/2"; Pistol airless AG14, filet 1/4", garda protectie duza; Duza dubla S10, 235/527; conector 1/4" NPSM x A=3/8" NPSM	7.331
024964249510	HeavyCoat 750E SSP Spraypack idem HC 750E Echipare standard idem HC 750E fara conectorul 1/4xA=3/8"	7.661
WA2371029	HeavyCoat 750G Spraypack motor Honda benzina Debit material 7.6 l/min. presiune 250 bar, duza max. 0.041" Echipare standard idem HC750 E	7.921
WA2332184	HeavyCoat 950 E Spraypack 230V, 3.1 kW Debit material 6 l/min., presiune 250 bar; Duza max. 0.052" Echipare standard: Furtun material DN13, max. 250bar 1/2", 15m furtun pentru manevrare DN10, max. 250 bar 3/8", 2,5m, conector 3/8" - 1/2" Pistol airless AG19, filet 1/4", 250 bar garda protectie duza Duza dubla reversibila S10, 235/527	7.600
0249642135804	HeavyCoat 950 E SSP Spraypack 230V, 3.1 kW Idem 950 E, echipat cu valva tip lopata pentru o performanta imbunatatita Echipare standard: unitate de baza; furtun DN13, 3/8", NPSM 1/2", 15m; furtun pentru manevrare DN10, NPSM 3/8", 2.5m; conector 3/8" x 1/2"; pistol airless AG19 filet 3/8"; garda protectie duza; duza dubla S20, 243/539	8.139
WA2332186	HeavyCoat 950 G Spraypack , motor Honda benzina Debit material 8 l/min.; presiune 250 bar; duza max. 0.052" Idem echipare HC 950 E	8.842
WA2332191	HeavyCoat 970 E Spraypack motor 400V, 5.5 kW Debit material 10.3 l/min. presiune 250 bar; duza max. 0.056" Echipare standard: unitate de baza; furtun material DN13, NPSM 3/8", 15m; furtun pentru manevrare DN10, NPSM 3/8", 2,5m; conector 3/8" x 1/2"; conector I=1/4"NPSM X A=3/8" NPSM; Pistol AG14 1/4"; garda protectie duza; duza dubla S20, 243/539	8.400
WA2332193	HeavyCoat 970 E SSP idem HC 970 E Echipare standard: unitate de baza; furtun material DN13, NPSM 3/8", 15m; furtun pentru manevrare DN10, NPSM 3/8", 2,5m; conector 3/8" x 1/2"; ; Pistol AG19 1/4"; garda protectie duza; duza dubla S20, 243/539	9.438
WA2332192	HeavyCoat 970 G motor Honda benzina Debit material 12 l/min. presiune 250 bar, duza max. 0.056" Echipare standard: idem HC 970 E	9.438
	SSP - Putere aditionala pentru materiale cu vascozitate mare	
	Accesorii pentru seria HeavyCoat	
WA2309956	Container 100L cu roti si capac	944
WA2383128	Conector container - HeavyCoat	276
	Ambele accesorii sunt compatibile cu toate pompele hidraulice Wagner si Titan, precum si Titan Performance1650.	



Additional power "Special-Spray-Power" for high viscosity materials



WA2361599 **SuperFinish 23i Cart**, motor 230V, 1,3 kW 1.350

Debit material 2,6 l/min., presiune 250 bar

Lichidare stoc

Echipare standard: Rezervor material 5 l, manometru

Accesorii de adaugat la versiunea de baza

4004025084928 Pistol airless Vector Pro 1/4", tragaci cu 4 degete duza 3 Tip 3 207

9984574 Furtun material DN6, max. 270 bar 15m, 1/4" 142

WA97057 Furtun pentru manevrare cu duza conectare injectoare 130

43052 Garnitura pentru instalarea duzei 1,1



4004025126475 **SuperFinish 23 CR**, motor 230V, 1,3 kW 2.056,7

Nou!

Debit material 2,6 l/min., presiune 250 bar;

Echipare standard: Unitate de baza fara alte accesorii

Accesorii de adaugat la versiunea de baza

4004025091599 Rezervor material 5L 117

WA2405950 Sistem de aspiratie material rigid (11) 132

WA2392123 Sistem de aspiratie flexibil (12) la cerere

WA2353487 Manometru presiune pentru injectari 400 bar (8) 216

024964206612 Pistol airless AG14 (otel inoxidabil) 273

WA9984574 Furtun material DN6 270 bar, 1/4" NPSM, 15m lungime 142

WA2353789 Furtun pentru manevrarea cu vana si cuplaj mama (5) 484

4004025091520 Furtun pentru manevrarea cu vana si cuplaj tata (6) 391

WA554XXX Duza HEA Pro 43,4

WA553XXX Duza TradeTip3 26,1

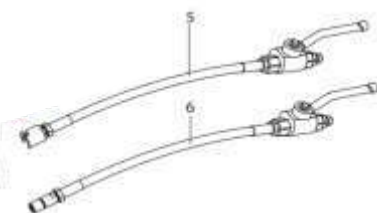

4004025086830 **PlastCoat 1030E Spraypack**, motor 230V, 2,2 kW 5.670

Debit material 15/ 20/ 25 l/min., presiune de operare 40 bar
Distanța max. pompare 50m, Înălțime max. 30 m
Granulometrie max. 6 mm

Echipare standard: furtun material DN25, M/V35, 10m, include furtun aer și cablu comanda, lance automată, include duza de 6 mm, trusa accesorii și accesorii curățare



WA2388301 **Pompa pentru materiale pastoase fluide** 6.480

PlastCoat HP30 Spraypack, motor 230V, 2,2 kW **NEW**

Debit material 10 kg/min., presiune de operare 120 bar
Distanța max. pompare 20m, Înălțime max. 15 m

Echipare standard: furtun material diam. Ø 19mm, lungime 10 m, furtun pentru manevrare Ø 13 mm, lungime 2,5 m pistol pulverizare, duza 443, garda protecție duza, rezervor material 50 l



WA2400684 Echipare opțională kit zugrăveli pentru Plast Coat HP30, include: furtun 489

material DN10, max. 270 bar, aer 3/8" - 15m

Pistol Vector Pro 1/4", duza HEA 517, adaptori 3/4-3/8"



WA258720 Echipare opțională kit decorative pentru Plast Coat HP30, include: furtun 478

material DN19, max. 270 bar, aer 1/4" - 15m, conector

Pistol AG19, 4buc. duza 4/6/8/10mm, perie pentru curățare

4004025098864 Adaptor pistol-cap/duza decorativă 27,7



WA2359240 **Malaxor continuu PlastMIX 15** 2.587



Motor 230V - 1,4 kW debit material 15 l/min., capacitate cuva 60 l, granulometrie max. 5 mm, cadru reglabil pe înălțime.

Include pompa de apă



WA2351453 **SteamForce PRO- echipament profesional pentru îndepărtarea tapetului** 508

Putere motor 2,75 kW / 230V - 50 Hz

Placa eliberare abur 253x305 mm și 140x70 mm

Capacitate rezervor apă 7,5 l; autonomie 90 min.

Timp necesar pentru încălzire echipament 18 min.

Furtun flexibil 5 m lungime

Greutate echipament: 9,4 kg



Cod produs	Descriere produs	Pret Euro (fara TVA)
------------	------------------	----------------------

Compressoare electrice

4004025075537	Compresor C330/03 compatibil cu PlastCoat 830 si 1030 Debit aer 330 l/min, presiune de lucru 10 bar, capacitate rezervor aer 3 l	808
---------------	--	-----



Lanci aplicare material

4004025074660	Lance in-wall aplicare automata include conexiunea electrica	447
WA2334122	Lance in-wall aplicare pneumatica	428
WA2334155	Cap drept pentru lance automata	72,3
4004025076305	Cap in unghi 70° pentru lancea pneumatica in-wall	244

Lance pneumatica



Lance automata



Accesorii pentru lanci

WA2335388	Accesoriu pentru dozare (compatibil cu lancile 2334155 si 2337672)	72,3
4004025076626	Accesoriu pentru adeziv (compatibil cu lancea 2334155 si 2337672)	60
	Deflector - duza din poliuretan pentru tencuieli si gleturi 10, 12, 14, 16, 18 mm (compatibil cu lancile 2334121 si 2337672)	la cerere
	Deflector - duza din otel inoxidabil pentru decorativa dim. 4, 5, 6, 7, 8, 9, 10, 12, 15 mm (compatibil cu lancile 2334155 si 2337672)	la cerere
4004025010477	Deflector - kit duze otel inoxidabil 4 / 6 / 8 / 10 mm (compatibile cu lancile 2334155 si 2337672)	134



WA2334123	Extensie lance 800 mm (compatibil cu cap lance 2334155)	293
WA2339400	Extensie lance 1.500 mm (compatibil cu cap lance 2334155)	330
WA296442	Extensie lance 2.000 mm (compatibil cu cap lance 2334155)	746
WA342321	Conector furtun V(tata)35 / M(mama)25	58,7
WA348920	Conector furtun V(tata)35 / M(mama)35	66,3
WA342215	Suport pentru sustinerea furtunului (ex. prindere pe schela)	32,2



WA2389048	Suport cu rola golire saci glet pentru HP30	881
-----------	---	-----



Rotoare si statoare

WA2395996	Set rotor si stator pentru HP30	620
WA348311	Stator W10/2.5, 270x89, negru pentru PC 1030 , PC25, PC35	112
WA348315	Stator W10/3, 270x89, galben pentru PC 1030 , PC25, PC35	114
WA348925	Stator W15/2, 270x89, maro pentru PC 1030 , PC25, PC35	116
WA2304954	Stator pentru PC830 , PC430	76,1
WA348312	Rotor W10/2.5 Ø40mm, L 317 mm, negru pentru PC1030 , PC25, PC35	133
WA348316	Rotor W10/3 Ø40mm, L 320 mm, galben pentru PC1030 , PC25, PC35	137
WA348926	Rotor W15/2 Ø40mm, L 320 mm, maro pentru PC1030 , PC25, PC35	134
WA2304986	Rotor pentru PC830	91,9



Cod produs

Descriere produs

Pret Euro (fara TVA)

C-DRYTOOLS C-DRYTOOLS Echipament cu set complet pentru chituire profesionala 1.295

(imbinare gips carton)

Utilizare pentru paste de imbinare lichide sau preamestecate ce se aplica pe imbinari de gips carton si / sau la aplicarea de coltare perforate, banda de imbinare si banda de aluminiu.

Include urmatoarele 10 elemente:

1. Aplicator pentru pasta imbinare (ipsos) la unghi exterior 90°
2. Aplicator pentru pasta imbinare (ipsos) la unghi interior 90°
3. Aplicator pentru pasta imbinare (ipsos) pentru imbinare plata
4. Role pentru finisare coltar exterior 90°
5. Role pentru finisare coltar interior 90°
6. Aplicator pentru pasta finisare la unghi interior 90°(prima mana)
7. Aplicator pentru pasta finisare la unghi interior 90°(a doua mana)
8. Pompa-Applicator pentru incarcare (se conecteaza la pozitiile 1,2,3)
9. Prelungitor (se conecteaza la pozitiile 4,5,6,7)
10. Conector pentru maner



C-BAZOOKA C-BAZOOKA Echipament pentru imbinari plane si colturi interioare gips carton, compus din rezervor pasta, suport rola imbinare, sistem de taiere a benzii de imbinare, cap aplicator pentru banda si pasta de imbinare, aplicare si presare banda in unghiuri interne. 2.467

Utilizare: pentru paste de imbinare lichide sau preamestecate ce se aplica pe imbinari de gips carton si / sau la aplicarea de coltare perforate, banda de imbinare si banda cu aluminiu.

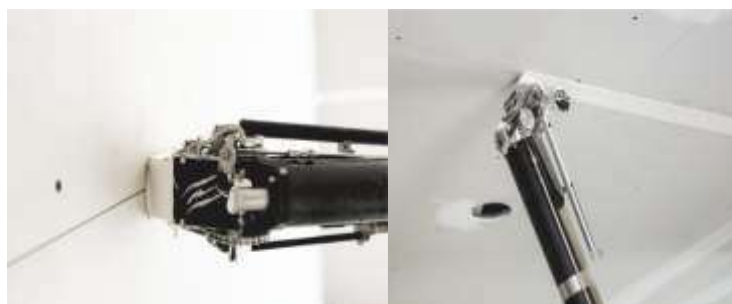

C-PUMP C-Pump Pompa pentru umplere cu pasta
Se utilizeaza cu art. C-Bazooka, C-BOX20, C-BOX25, C-BOX30

460

C-GOOSENECK C-Gooseneck Conector pompa Bazooka
Se utilizeaza pentru conexiunea pompei C-PUMP cu C-BAZOOKA

145

C-APB C-APB Conector pompa - BOX
Se utilizeaza pentru conexiunea pompei C-PUMP cu accesoriile C-BOX

88,3

C-MBOX C-MBOX Maner 1.800 mm lungime, 1,36 kg, pentru aplicatoare BOX
Se utilizeaza impreuna cu C-BOX20, C-BOX25 si C-BOX30

230

C-MBOX106 Maner pentru aplicatoare C-Box Columbia C-MBOX106 L=106cm

255

C-MBOX92 Maner pentru aplicatoare C-Box Columbia C-MBOX92 L=92cm

220

C-MBOX180 Maner pentru aplicatoare Columbia C-MBOX180

230

Cutie pentru aplicare pasta pe imbinari drepte (se utilizeaza cu MBOX)

C-BOX25 C-BOX25 - latime 250 mm, greutate 1,43 kg

542

C-BOX30 C-BOX30 - latime 300 mm, greutate 1,74 kg

550

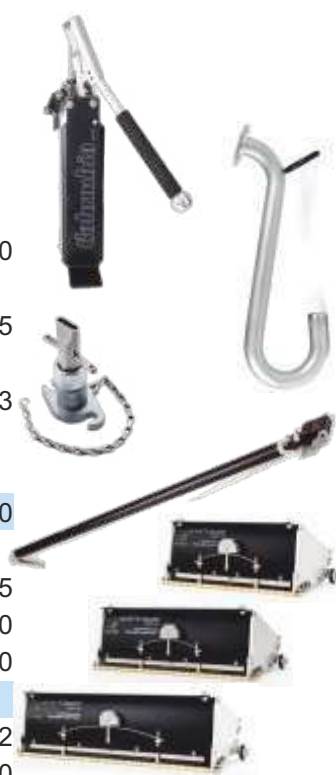

Cod produs

Descriere produs

 Pret Euro
 (fara TVA)

4035834200001 **Chameleon** - Masina universala pentru slefuit, curatat, polisat, indepartat tapet, toate intr-o singura masina
 Putere motor 1 kW; viteza rotatie 150 - 570 rpm
 Greutate echipament slefuire: 2,2 kg

Discuri cu diametru Ø200 mm pentru 20000 Chameleon

Discuri pentru curatarea rezidurilor de beton, rugina de pe cadre metalice (1)

21200 Disc perie otel: fin, mediu sau dur (fig. 1) 132

21300 Disc special din otel: mediu sau dur (fig. 2) 132

21500 Disc din nylon: super fin, fin, dur (fig. 2) 132

Disc curatare fatade cladiri cu efect de marmura sau parchet

23400 Disc curatare granulometrie 80, 120, 180 (fig. 3) 20,0

23600 Disc polisare din piele foarte fin (fig. 4) 45,0

20100 Disc zgariere long life poate fi utilizat pentru indepartarea fibrei de sticla (fig. 5) 67,0

4035834217009 Disc Widia pentru indepartarea tencuiei sau reziduu de adeziv (fig. 6) 198

RK2025200 Disc pentru netezirea betonului (aplicat cu lancea) (fig. 7) Set 2 buc. 54,0

RK2025000 Disc pentru netezirea betonului cu baza prindere (aplicat cu lancea) 62,0

4035834222508 Pachet Premium pentru indepartarea tapetului: disc perforat (fig. 1) plus disc raschetare (fig. 4) + sine ghidaj (fig. 5) + placa pt ascutire lame discuri 286

22700 Disc pentru netezirea betonului tip elicopter (fig. 1) 54,0

22600 Disc pentru nivelare cu lame tip mistrie (fig. 2) 110

22200 Discuri perforante pentru indepartarea tapetului (fig. 3) 160

22300 Discuri raschetare (fig. 4) 108

22210 Sine de ghidaj utilizare cu discurile de perforare si raschetare (fig. 5) 46,0

20700 Discuri sustinere velcro pentru montare discuri de slefuire, metalice (fig. 6) 39,0

4035834208168 Disc slefuire granulometrie 16, 4 buc. (pentru polistiren) (fig. 7) 15,5

4035834208243 Disc slefuire granulometrie 24, 4 buc. (pentru gips) 11,3

20840 Disc slefuire granulometrie 40, 6 buc. (pentru gips) 14,8

20860 Disc slefuire granulometrie 60, 6 buc. (pentru gips) 13,3

20880 Disc slefuire granulometrie 80, 6 buc. 12,4

20810 Disc slefuire granulometrie 100, 6 buc. 12,0

20812 Disc slefuire granulometrie 120, 6 buc. 12,0

28040 Discuri Jost granulometrie 40, 60, 80 (fig. 1) 29,0

28012 Discuri Jost granulometrie 120, 180, 220 (fig. 1) 24,0

27080 Grila raschetare granulometrie 80 (fig. 2) 21,0

27010 Grila raschetare granulometrie 100, 120, 180, 220 (fig. 2) 27,0

4035834224052 Disc abraziv metalic fin Set 2 buc.(fig. 3) 90

RK2023200 Disc abraziv metalic mediu (fig. 3) Set 2 buc. 121

RK22900 Disc abraziv metalic dur (fig. 3) 138

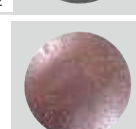
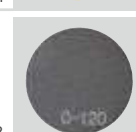
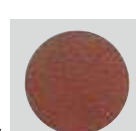
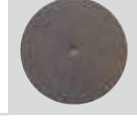
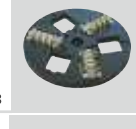
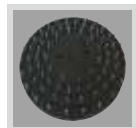
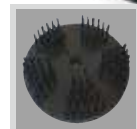

Cod produs	Descriere produs	Pret Euro (fara TVA)
4035834601006	Heron - Slefuitor telescopic - cel mai usor echipament telescopic Motor electric 1,5 kW, viteza rotatie 640-2.270 rpm Greutate echipament slefuire: 2,4 kg	1.137
60150	Discuri cu diametru Ø 225mm pentru Heron Suport baza Ø 225mm cu baza din spuma si arici (fig. 1)	70,0
62200	Discuri pentru curatare si polis Disc slefuire granulometrie 80 (fig. 2)	60,0
62000	Disc slefuire granulometrie 120 (fig. 2)	53,6
62100	Disc slefuire granulometrie 180 (fig. 2)	60,0
62800	Pad polisare foarte fin (fig. 2)	30,0
	SuperPad discuri pentru vopsire profesionale si lacuire	
61100	SuperPad granulometrie 40, set 6 buc. (fig. 4)	23,0
61200	SuperPad granulometrie 60, set 6 buc. (fig. 4)	20,0
RK2061300	SuperPad granulometrie 80, set 6 buc. (fig. 4)	17,5
RK2061400	SuperPad granulometrie 100, set 6 buc. (fig. 4)	15,5
RK2061500	SuperPad granulometrie 120, set 6 buc. (fig. 4)	15,8
61600	SuperPad granulometrie 150, set 6 buc. (fig. 4)	17,0
	Discuri Jost cu perforatii pentru extractia prafului - sistem brevetat	
69840	Disc slefuire granulometrie Jost 40, set 6 buc. (fig. 5)	31,0
69860	Disc slefuire granulometrie Jost 60, set 6 buc. (fig. 5)	20,0
4035834698808	Disc slefuire granulometrie Jost 80, set 6 buc. (fig. 5)	27,3
4035834698129	Disc slefuire granulometrie Jost 120, set 6 buc. (fig. 5)	26,4
4035834698181	Disc slefuire granulometrie Jost 180, set 6 buc. (fig. 5)	26,4
	Grila raschetare pentru tencuieli, materiale de umplere	
RK2069780	Grila raschetare granulometrie 80, set 4 buc. (fig. 6)	22,0
69710	Grila raschetare granulometrie 100, set 6 buc. (fig. 6)	31,0
69712	Grila raschetare granulometrie 120, set 6 buc. (fig. 6)	31,0
69718	Grila raschetare granulometrie 180, set 6 buc. (fig. 6)	31,0
69722	Grila raschetare granulometrie 220, set 6 buc. (fig. 6)	31,0
	Slefuirea lemnului, caramizilor, fibrei de sticla, beton si alte materiale	
60500	Disc abraziv metalic fin (fig. 7)	79,0
RK2060600	Disc abraziv metalic mediu (fig. 7)	80,9
RK2060700	Disc abraziv metalic dur (fig. 7)	90,5
4035834610053	Baza din spuma 7mm pentru sustinerea discului abraziv metalic	30,2
60300	Pentru slefuirea betonului, sapelor etc. Disc abraziv diamantat pentru beton, sape (fig. 8)	180
4035834120002	Aspirator tip rucsac compatibil cu echipamentele Chameleon si Heron	1.242
4035834100004	Aspirator electric - conectare la retea	691

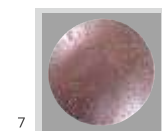
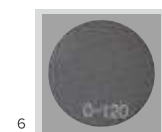
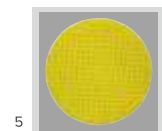
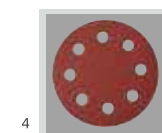
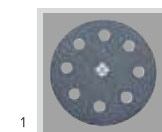

Cod produs	Descriere produs	Pret Euro (fara TVA)
------------	------------------	----------------------

RK30000	Rokamat Dry (PFM) - Masina de finisat uscat pentru tencuieli si gleturi mecanizate	1.063
---------	--	-------

Disc slefuire Ø350 mm, motor electric 1 kW, turatie disc 75 - 340 rpm
 Greutate echipament slefuire: 2,4 kg



4035834400005	Rokamat Wet (PFM W) - Masina de finisat umed pentru tencuieli si gleturi mecanizate	1.233
---------------	---	-------

Disc slefuire Ø350 mm, Motor electric 1 kW, turatie disc 75 - 340 rpm
 Conexiune apa direct la retea
 Greutate echipament slefuire: 2 kg

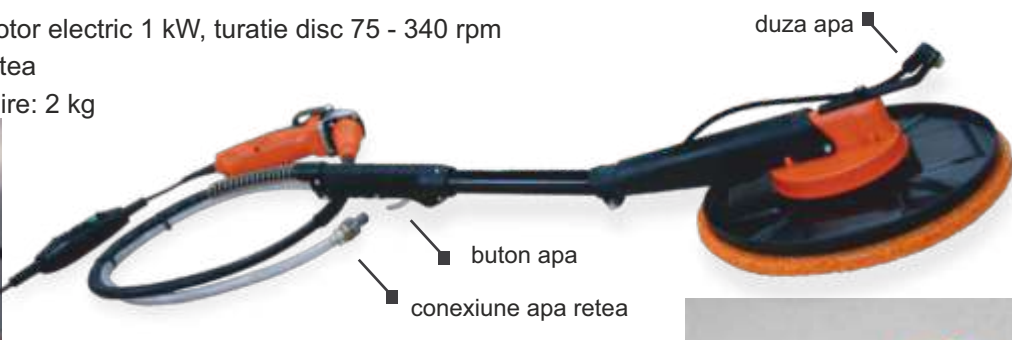

4035834700006	Nautilo (PFM WT) - Masina de finisat umed pentru tencuieli si gleturi mecanizate	1.443
---------------	--	-------

Disc slefuire Ø350 mm, Motor electric 0,6 kW; turatie disc 75 - 340 rpm
 Rezervor apa 6 l tip rucsac
 Greutate echipament slefuire: 2,1 kg



Accesorii Rokamat Dry (PFM), Wet (PFM W), Nautilo (PFM WT)

4035834480007	Disc Ø350 mm cu velcro (arici) (fig. 1)	48,9
---------------	---	------

Pentru netezirea tencuielilor

4035834481004	Disc polis perforat (fig. 2)	38,6
---------------	------------------------------	------

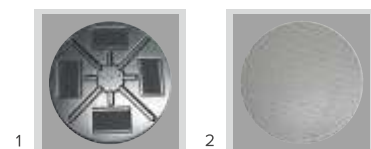
RK2049400	Disc polis fin (fig. 2)	37,3
-----------	-------------------------	------



Finisare ipsos, tencuieli de ciment/calcar, umplutura ultraspongioasa

4035834493007	Disc din burete dur (fig. 3)	28,2
---------------	------------------------------	------

4035834494004	Disc din burete fin (fig. 4)	37,3
---------------	------------------------------	------

RK48300	Disc din burete cu capac din plastic dur (fig. 3)	32,5
---------	---	------

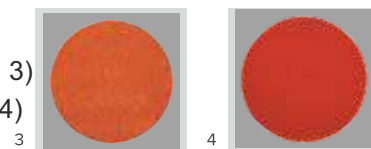
RK2048200	Disc din burete cu capac din plastic fin (fig. 4)	39,2
-----------	---	------

Pentru suprafete fine

RK49500	Disc din burete super fin cu velcro (fig. 5)	22,2
---------	--	------

48500	Disc din burete super fin cu capac din plastic si velcro (fig. 5)	29,5
-------	---	------

49800	Burete albastru cu velcro	23,3
-------	----------------------------------	------

49900	Burete maro cu velcro (fig. 6)	23,3
-------	--------------------------------	------

Pentru tencuieli fine

RK2048800	Structura inel pentru burete Hydro (fig. 7)	37,7
-----------	---	------

Pentru indepartarea urmelor de var sau ciment

49600	Disc din pasla (fig. 8)	56,0
-------	-------------------------	------

Ideal pentru orice tip de finisaj

34300	Disc comparator pentru finisarea tencuielilor Ø450 mm (fig. 9)	271
-------	--	-----

34305	Pachet premium Multi finish gips	364
-------	----------------------------------	-----

Contine burete cu capac din plastic, placa suport si pad slefuire



Cod produs

Descriere produs

Pret Euro (fara TVA)

RK93000 **SKATE** - Masina telescopica pentru finisare beton 1.157

Nou!

Disc slefuire Ø350 mm, motor electric 1 kW, turatie disc 85 - 340 rpm
 Greutate echipament slefuire: 3,1 kg



Accesorii SKATE

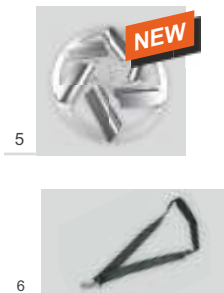

- | | | | |
|---------|---|--|------|
| 48900 | Disc Ø350 mm cu velcro (arici) (fig. 1) |  | 112 |
| 48100 | Disc polish perforat (fig. 2) |  | 39,2 |
| 48200 | Disc polish Ø350 mm cu velcro (arici) (fig. 3) |  | 39,2 |
| 48900 | Disc (oțel inoxidabil) cu velcro, neted, „longlife” Ø 350 mm (fig. 4) |  | 112 |
| 34900 | Disc (oțel inoxidabil) cu velcro, neted, „longlife” Ø 215 mm (fig. 4) |  | 107 |
| 69110 | Baza disc (de folosit cu pad nr. 34900) |  | 20,0 |
| 93100 | Disc cu lame Ø 450 mm (fig. 5) |  | 275 |
| RK05100 | Curea pentru umar (fig. 6) |  | 46,4 |



4035834902004 **Piranha Cutter** - Echipament special crearea santurilor pentru cabluri 1.091

Disc 115 mm sau 125 mm. Putere motor 1,5 kW; turatie 2.800 - 9.100 rpm
 Greutate echipament taiere 1,7 kg

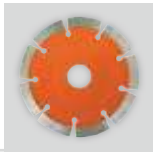

- | | | | |
|-----------|---|--|------|
| RK2090120 | Disc taiere diamantat Ø 115mm (fig. 2) Set 3 buc. | | 54,0 |
| RK2090121 | Disc taiere diamantat Ø 125mm (fig. 2) |  | 60,2 |
| RK05100 | Curea pentru umar (fig. 3) |  | 46,4 |

4007430250124 **Aspirator electric uscat-umed ASR 35 M SCP**. Putere motor 1,4 kW - 919

Nou!

230V, Volum rezervor 35 l, debit aer 262,8 m³/h. Greutate 16 kg.
 Priză pentru conectarea unei unelte electrice (ex.: slefuitor);
AutoCleanPlus: curatare automata a filtrului MPulse in timpul utilizării continue.



SCHELE | COFRAJE | PANOURI

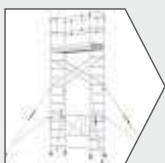

Schela mobila profesionala Protube
Pagina 77



Scari si schele profesionala
Pagina 81



Panou galben
Pagina 84



Panou TEGO
Pagina 85



Grinda H20
Pagina 86

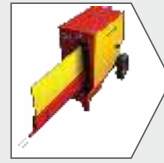

Accesorii pentru cofraje
Pagina 87



Accesorii pentru cofraje
Pagina 88



Popi metalici si trepiezi
Pagina 92

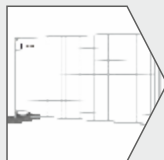

Sistem mobil EU2 Garduri
Pagina 93



Tubulatura evacuare deseuri | Parapeti rutieri
Pagina 94



Schela mobila profesionala din aluminiu ProTUBE L

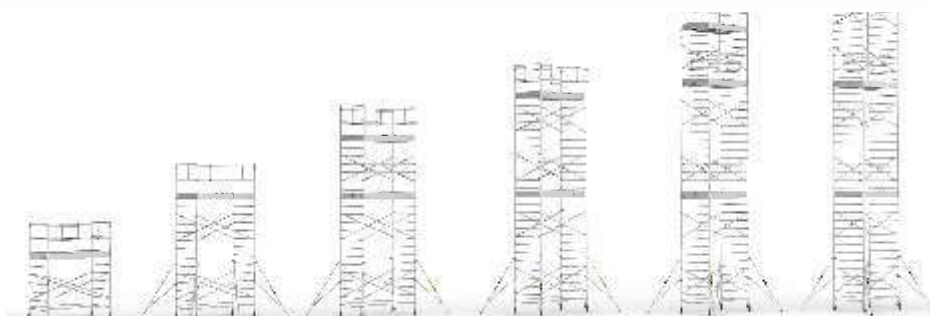

Schela mobila AL, ProTube L, dim. platforma = 120x240cm, incl. 1 plan lucru Pret Euro (fără T.V.A.)	PROTUBE L4 Hlucru = 4,1m	PROTUBE L6 Hlucru = 6,2m	PROTUBE L8 Hlucru = 8,3m	PROTUBE L10 Hlucru = 9,8m	PROTUBE L12 Hlucru = 12,5m	PROTUBE L14 Hlucru = 13,8m
	1.544	2.177	2.734	3.046	3.669	3.981

Descriere elemente Schela ProTube L	Pret unitar € (fără T.V.A.)	Numar elemente Schela ProTube L					
Cadru schela 7 trepte PT223M Cod: 8697817587118	126,8	2	4	6	6	10	10
Cadru schela 5 trepte PT163M Cod: 8697817588351	93,6	0	0	0	2	0	2
Ranforsare orizontala PT259Y Cod: 8697817587170	29,8	2	2	8	8	14	14
Ranforsare diagonala PT275C Cod: 8697817587156	31,1	4	8	12	16	20	24
Podea cu trapa PT258KP Cod: 8697817587132	213,0	1	1	1	1	1	1
Podea fara trapa PT258K Cod: 8697817587149	193,0	1	1	1	1	1	1
Roata cu frana PT200TE Cod: 8697817587194	76,6	4	4	4	4	4	4
Parapet de capat PT110K Cod: 8697817587125	53,3	2	2	2	2	2	2
Parapet lateral PT259H Cod: 8697817587163	66,3	2	2	2	2	2	2
Stabilizator PT276PA Cod: 8697817587187	63,8	0	4	4	4	4	4
Protectie picioare PT302TM Cod: 8697817587200	155,1	1	1	1	1	1	1

Optional:

Plan de lucru suplimentar: PT258KP (8697817587132)+ PT258K (8697817587149) + PT302TM (8697817587200) **561 €**



Schela mobila profesionala din aluminiu ProTUBE S

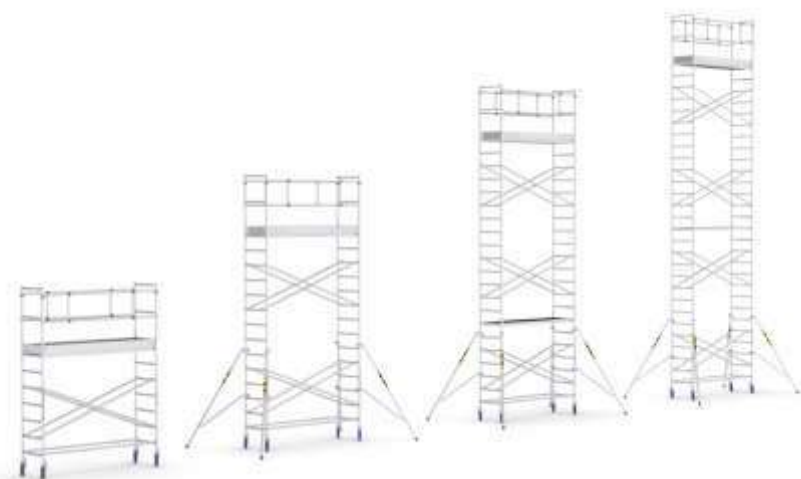

Schela mobila AL, ProTube S, dim. platforma = 60x240cm, incl. 1 plan lucru Pret Euro (fără T.V.A.)	PROTUBE S4 Hlucru = 4,1m	PROTUBE S6 Hlucru = 6,2m	PROTUBE S8 Hlucru = 8,3m	PROTUBE S10 Hlucru = 10,4m
	1.224	1.782	2.085	2.388



Descriere elemente Schela ProTube S	Pret unitar € (fără T.V.A.)	Numar elemente Schela ProTube S			
Cadru schela 7 trepte PTS223M Cod: 8697817588368	89,2	2	4	6	8
Ranforsare orizontala PT259Y Cod: 8697817587170	30,0	2	2	2	2
Ranforsare diagonala PT275C Cod: 8697817587156	31,1	4	8	12	16
Podea cu trapa PT258KP Cod: 8697817587132	213,0	1	1	1	1
Roata cu frana PT200TE Cod: 8697817587194	76,6	4	4	4	4
Parapet de capat PTS110K Cod: 8697817588399	42,6	2	2	2	2
Parapet lateral PT259H Cod: 8697817587163	66,3	2	2	2	2
Stabilizator PT276PA Cod: 8697817587187	63,8	0	4	4	4
Protectie picioare PTS302TM Cod: 8697817588436	124,3	1	1	1	1

Optional:

Plan de lucru suplimentar: PT258KP (8697817587132) + PTS302TM (8697817588436) **337 € (+TVA)**



Schela mobila profesionala din aluminiu ProTUBE F



Schela mobila AL, ProTube F, dim. platforma = 60x180cm, incl. 1 plan lucru Pret Euro (fără T.V.A.)	PROTUBE F90 Hlucru = 2,7m	PROTUBE F180 Hlucru = 3,6m	PROTUBE F360 Hlucru = 5,4m
	427	788	1.317

Descriere elemente Schela ProTube F	Pret unitar € (fără T.V.A.)	Numar elemente Schela ProTube F		
Etaj de baza PT192M Cod: 8697817589266	202,8	1	1	1
Cadru schela 6 trepte PTF223ME Cod: 8697817588382	78,0	-	-	2
Pin conector cadre PT18C Cod: 8697817589051	3,2	-	4	8
Ranforsare orizontala PTF182Y Cod: 8697817588412	24,7	-	1	1
Ranforsare diagonala PTF202C Cod: 8697817588283	26,4	-	1	5
Podea cu trapa PTF183KP Cod: 8697817589303	167,7	1	1	1
Roata cu frana PT125TE Cod: 8697817588450	14,2	4	4	4
Parapet de capat PTS110K Cod: 8697817588399	42,6	-	2	2
Parapet lateral PTF182H Cod: 8697817588467	53,8	-	2	2
Stabilizator PT276PA Cod: 8697817587187	63,8	-	-	4
Protectie picioare PTF180TM Cod: 8697817588290	103,9	-	1	1

Optional:

Plan de lucru suplimentar: PTF183KP (8697817589303) + PTF180TM (8697817588290) **272 € (+TVA)**



Schele profesionale din aluminiu

Cod produs

Descriere produs

Pret Euro (fara TVA)

8697817590910 **ProTUBE Mini7** Schela mobila profesionala din aluminiu H lucru 6,8m, 1.505

Nou!

plan antiderapant 60x100cm, roti pivotante cu blocator, stabilizatori ajustabili,

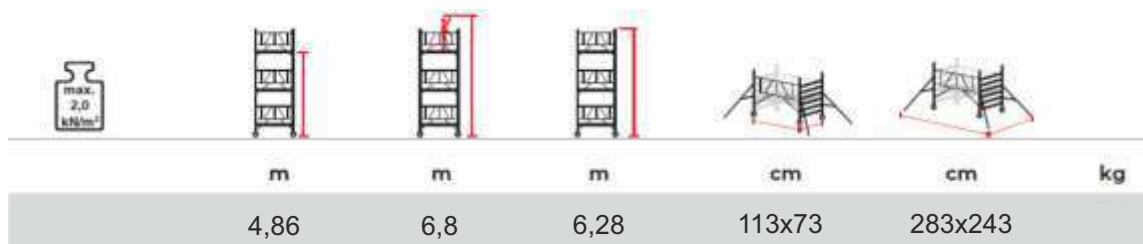

Nou!

SCHELA TURN ProTOWER

SCHELA TURN ProTOWER	MODEL	TURN L6	TURN L7	TURN L9	TURN L11	TURN L12
	Pret Euro (fără T.V.A.)	2.777	3.324	3.996	4.619	5.234
	Inaltime la ultima treapta	5,4m	7,2m	9,0m	10,8m	12,6m
	Inaltime schela	7m	8,6m	10,2m	12m	13m
Descriere elemente Schela turn ProTOWER		Numar elemente Schela turn ProTOWER				
Scara cu balustrade H1,8m PT320ME, Cod: 8697817591306		3	4	5	6	7
Baza reglabila filetata 750mm vopsita, Cod: CG0059009		4	4	4	4	4
Ancoraj 40cm cu pini, Cod: RO0008402		2	3	4	5	6
Morseta fixa octogonala, Cod: CG0003611		2	3	4	5	6
Cadru schela 7 trepte PT223M Cod: 8697817587118		4	4	4	10	10
Cadru schela 5 trepte PT163M Cod: 8697817588351		2	4	6	0	2
Ranforsare orizontala PT259Y Cod: 8697817587170		8	8	12	14	14
Ranforsare diagonala PT275C Cod: 8697817587156		12	16	18	20	24
Podea fara trapa PT258K Cod: 8697817587149		1	1	1	1	1
Parapet de capat PT110K Cod: 8697817587125		2	2	2	2	2
Parapet lateral PT259H Cod: 8697817587163		2	2	2	2	2



Scari / Schele din aluminiu

Cod produs	Descriere produs	Pret Euro (fara TVA)
8697817590057	TeleSafe 005XL - Schela mobila completa, Hlucru = 5,60m, plan 60x155cm	938
8697817590071	TeleSafe 007XL - schela mobila completa, Hlucru = 7,00m, plan 60x155cm	1.092
8697817590088	TeleSafe 008XL - schela mobila completa, Hlucru = 7,85m, plan 60x155cm	1.356

TeleSafeXL



Optionale:

8697817591313	Kit 4 stabilizatoare 1.800 mm TelesafeXL (1)	60,0
	PLT155x60 Platforma de lucru pentru TeleSafe XL (2)	636
	TEK45678XL Protectie picioare pentru platforma de lucru TeleSafe XL (3)	236
	Q1710100 Ranforsare orizontala pentru TeleSafe XL (4)	18,2

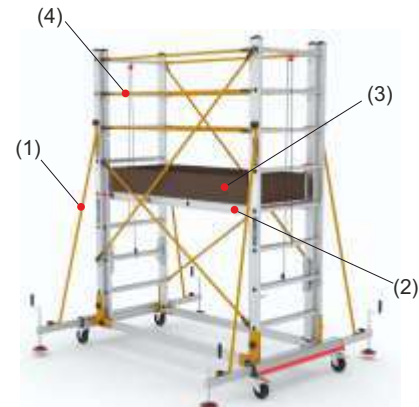

8697817585671	TeleSM 460 - Schela mobila completa, Hlucru = 4,74m, plan 60x155cm	826
8697817585688	TeleSM 640 - schela mobila completa, Hlucru = 6,70m, plan 60x155cm	968



TeleSM

8697817585855	TelePL - PL002 Scara dubla si schela fara roti, Hlucru = 4,40m, plan 45x155cm	352
---------------	--	-----



Platforme mobile profesionale din aluminiu

8697817585787 **Platforma EP4** - Platforma mobila cu 4+1trepte, Hlucru=3,05m podea 60x60cm

826

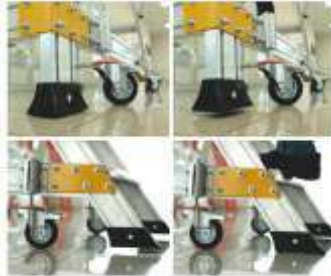

EP4

8697817588672 **Platforma RD28** - Platforma mobila profesionala cu 3+1trepte, Hlucru=2,8m podea 60x50cm

548

8697817585701 **Platforma RD33** - Platforma mobila profesionala cu 5+1trepte, Hlucru=3,3m podea 60x50cm

620

8697817585718 **Platforma RD38** - Platforma mobila profesionala cu 7+1trepte, Hlucru=3,8m podea 60x50cm

735



RD28



RD33



RD38



Certificate
EN 131-7
Norm



Foia cofrantă este panoul tradițional de cofrare culoare galbenă și vine, în principal, pentru segmentul de construcții rezidențiale. Panoul de foaie cofrantă are o structură solidă, fiind compus din trei straturi încleiate și tratate la suprafață cu rășină melaminică rezistentă la apă.

Sunt disponibile diverse dimensiuni, grosimi standard 21 și 27mm, la cerere se pot livra și grosimi speciale. Poate fi utilizată atât pentru pereți cât și pentru planșee, suprafața betonului finit având aspect curat.

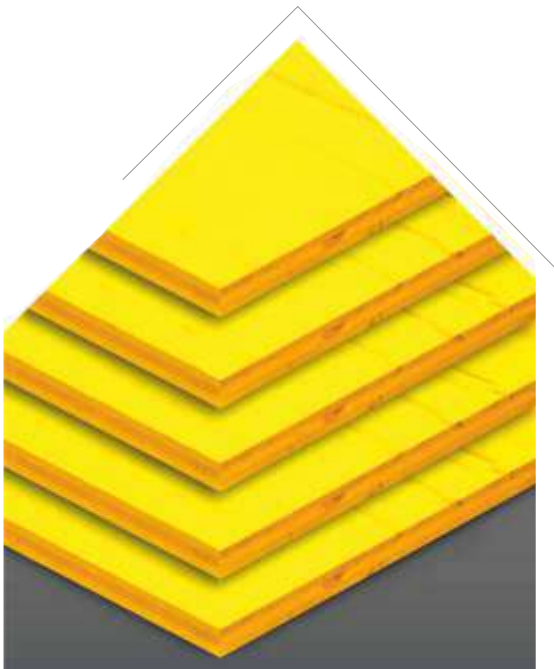

Panou galben cant metalic 21mm



Panou galben stratificat de 21 mm sau 27 mm.

Panourile lățime 50cm sunt disponibile atât fără profil de protecție a marginilor, cât și cu profil metalic de protecție pe lățime.

Panoul de cofraj din plastic este fabricat din polipropilenă de înaltă calitate. Se caracterizează prin rigiditate ridicată, rezistență la căldură, rezistență la coroziune și are o rezistență la impact mult mai mare. Nu este necesar ulei de deformare, iar dezamblarea cofrajului este întotdeauna ușoară.

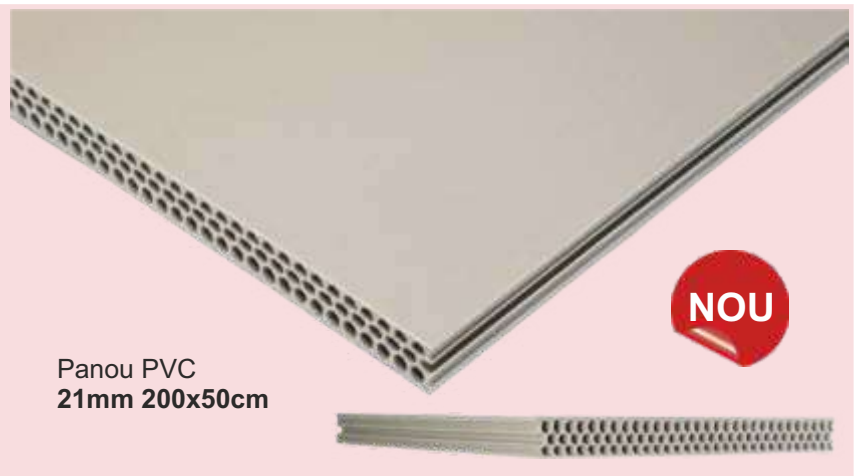

Panou PVC 21mm 200x50cm

Foie cofrantă

COD	Denumire	Solicita oferta!
CG11949	Panou galben 21mm 200x50cm	
CG11949-C	Panou galben cant metalic 21mm 200x50cm	
CG11953	Panou galben 27mm 250x50 cm	
CG11952	Panou galben 27mm 200x50 cm	
CG0009295	Panou PVC 21mm 200x50cm	

Panou cofrare tip TEGO este confecționat din furnire de plop suprapuse, în straturi, adeziva cu adezivi fenolici rezistenți la apă, având suprafețele acoperite cu film fenolic de culoare negru sau maro.

Panou este folosit îndeosebi la cofrare, în construcții, pentru care oferă un număr mare cicluri de turnare.

Panou stratificat este un semifabricat din lemn sub formă de placă, realizat prin incleierea sub presiune a unui număr de foi de furnir suprapuse, fiecare strat având fibră lemnoasă dispusă perpendicular pe straturile adiacente, folosit la fabricarea mobilelor, a ambalajelor, a ambarcațiunilor, că suport pentru parchetul adezivat sau aplicat, cofrarea în construcții în vederea turnării betoanelor, etc.

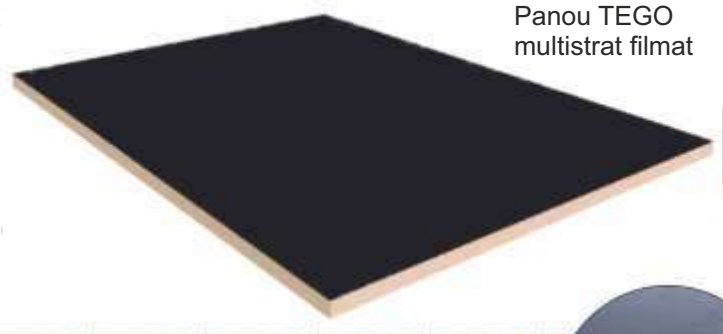

Panou TEGO multistrat filmat



Nici un alt produs din lemn nu poate fi utilizat pe o scară atât de largă ca panoul.

Proprietățile deosebite oferite de placaj sunt: rezistență mecanică, elasticitate, inconviere, imunitate ridicată la schimbările bruște ale temperaturii sau umidității, fac din acest material unul dintre cele mai utilizate.

Ofertă vânzare foaie cofrantă

COD	Denumire	Solicita oferta!
CGTEGO-2/2.97	Panou multistrat (Tego) 21mm 244 x 122 cm, nereciclat, plop	
CGTEGO-1/2.97	Panou multistrat (Tego) 20 mm 244 x 122 cm, reciclat, plop	
CGTEGO-2/1.56	Panou multistrat (Tego) 21mm 250x62.5cm, nereciclat, plop	



Grinzi susținere din lemn.

Ofertă vânzare grindă lemn H20

COD	Denumire	SOLICITA OFERTA!
CG20046W	Grinda H20 1,45m	
CG20047W	Grinda H20 1,80m	
CG20050	Grinda H20 2,15m	
CG0009375	Grinda H20 2,45m	
CG20049	Grinda H20 2,65m	
CG20041	Grinda H20 2,90m	
CG20042	Grinda H20 3,30m	
CG20043W	Grinda H20 3,60 m	





Paolina este solutia ideala pentru curatarea panourilor de cofraj din lemn latime de 50 cm, putand curata fara probleme cele doua fete vizibile ale placilor de cofraj si canturile acestora.

În plus, Paolina dispune de role de sfărâmare, lame duble pe fiecare parte, perii de praf și sistem automat de aplicare și finisare a decofrantului.

„Paolina” este o mașină ce se produce de peste 28 de ani, si are peste 8.000 de unități produse și vândute în toată Europa.



LA PAOLINA
Masina de curatat panouri
COD: PL1003078

Solicita oferta!



Masina de curatat panori LA PAOLINA

Număr de role de sfărâmare	2 orizontale + 2 verticale
Numar de lame curatare	6 orizontale + 4 verticale
Numar de perii de praf	2
Număr lame cauciuc pentru aplicare	2 orizontale + 2 verticale
Putere motor 230V	0,75 Kw / 1CP
Puterea pompei 230V	0,11 kW
Viteza de curatare	780 ml/h
Grosimea min./max.	22 / 37 mm
Latime	500 mm
Capacitate rezervor decofrant	30 litri
Nivel acustic	74 dB
Dimensiuni mașină în faza de lucru	2.730 / 780 / 1.040 mm
Greutate	225 kg

BISCUIT H15x45
COD: RO0009296



Set 500 buc. **15,2 €**

BISCUIT H20x45
COD: RO0009297



Set 500 buc. **21,4 €**

BISCUIT H25x50
COD: RO0009298



Set 500 buc. **34,2 €**

BISCUIT H30x50
COD: RO0009299



Set 500 buc. **35,7 €**

ROZETĂ H20
COD: RO0009300



Set 500 buc. **16,6 €**

ROZETĂ H25
COD: RO0009301



Set 500 buc. **17,7 €**

ROZETĂ H25-XL
COD: RO0009302



Set 500 buc. **13,7 €**

ROZETĂ H30
COD: RO0009303



Set 500 buc. **18,3 €**

SOLICITA OFERTA!

ROZETĂ H35
COD: RO0009304



Set 500 buc. **34,0 €**

ROZETĂ H40
COD: RO0009305



Set 250 buc. **17,9 €**

ROZETĂ H50
COD: RO0009306



Set 250 buc. **24,4 €**

FAGURE H30
COD: RO0009307



Set 500 buc. **31,5 €**

FAGURE H50
COD: RO0009308



Set 250 buc. **43,0 €**

FAGURE H70
COD: RO0009309



Set 250 buc. **72,9 €**

TRAPEZOIDAL
H40-50
COD: RO0009312



Set 250 buc. **26,7 €**

CILINDRIC CH25
COD: RO0009310



Set 500 buc. 16,0 €

CILINDRIC CH50
COD: RO0009311



Set 500 buc. 44,5 €

ARMĂTURĂ H25
COD: RO0009313



Set 500 buc. 23,6 €

ARMĂTURĂ H50
COD: RO0009314



Set 250 buc. 20,6 €

CON CU DOP 22MM
COD: RO0009315



Set 500 buc. 15,8 €

CON fără DOP
COD: RO0009316



Set 500 buc. 12,1 €

ȚEAVĂ PVC PENTRU PROTEJAREA TIJEI
FILETATE, Ø22MM, L=2M
COD: CGPPD22



0,39 €

SOLICITA OFERTA!

PROFIL
TRIUNGHIULAR
L=2M

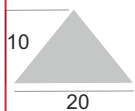

20MM, L=2ML
COD: ROPST20
Preț/ml

0,27 €

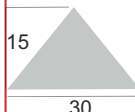

30MM, L=2ML
COD: ROPST30
Preț/ml

0,42 €



DISTANȚIERI FIER-BETON ARMARE PLACĂ NLF,
L=2M



COD: RO480590003

0,54 €

COD: RO480590015

0,68 €

COD: RO480590010

1,6 €

CRAVATE ZINCATE
15-45CM
COD: CGGCRZ



Set 4 buc. 31,8 €

CAPAC PROTECȚIE
ROȘU
Ø 16MM
COD: ROPCPF620



0,16 €

PROFIL U ZINCAT
50CM
COD: CGSUZ50



1,3 €

PROFIL U ZINCAT
100CM
COD: CGSUZ100



2,6 €

PROFIL U ZINCAT
150CM
COD: CGSUZ150



5,6 €



PANĂ METALICĂ
COD: 3877002091254



Set
100 buc. 19,0 €

DISTANȚIER
METALIC 15CM
COD: 3877002091025



Set
100 buc. 9,05 €

DISTANȚIER
METALIC 20CM
COD: CGDT20



Set
100 buc. 10,5 €

DISTANȚIER
METALIC 25CM
COD: 3877002091049



Set
100 buc. 12,0 €

DISTANȚIER
METALIC 30CM
COD: 3877002091056



Set
100 buc. 13,6 €

SOLICITA OFERTA!

DISTANȚIER
METALIC 35CM
COD: 3877002091063



Set
100 buc. 15,3 €

DISTANȚIER
METALIC 40CM
COD: 3877002091070



Set
100 buc. 17,7 €

DISTANȚIER
METALIC 45CM
COD: CGDT45



Set
100 buc. 19,2 €

DISTANȚIER
METALIC 50CM
COD: 3877002091094



Set
100 buc. 21,0 €

DISTANȚIER
METALIC 55CM
COD: 3877002091100



Set
100 buc. 38,8 €

DISTANȚIER
METALIC 65CM
COD: 3877002091124



Set
100 buc. 26,5 €

DISTANȚIER
METALIC 85CM
COD: 3877002091162



Set
100 buc. 33,3 €

CLEMĂ CU PANĂ
COFRAJE
COD: Cg54600



1,5 €



CHEIE DE
TENSIONARE
COD: CG54610



17,0 €

PIULIȚĂ FIXĂ DW15
COD: CGA121Z



1,7 €

TIRANT DW15
L=300CM
Ø 16MM
COD: CGPF300N



9,1 €

Decofrant soluție **ALCHIOIL 100**

- Ambalaj: bidoane de 10l, 25l
- Ulei sintetic, ajută / înlesnește procesul de decofrare
- Se utilizează pentru acoperirea panourilor de cofraj cu foaie TEGO sau alte materiale, foaie galbenă, etc.
- **Nu se diluează**
- **Acoperire conform recomandări producător: 50 – 60 m²/litru (nediluat)**
- Se aplică cu trafalet sau prin pulverizare cu pompă, înainte de fiecare turnare



Bidon 10L
COD: CGPFPR025

26,8 €

Bidon 25L
COD: CGPFPR008

74,1 €

Bidon 210L
COD: CGPFPR031

607 €

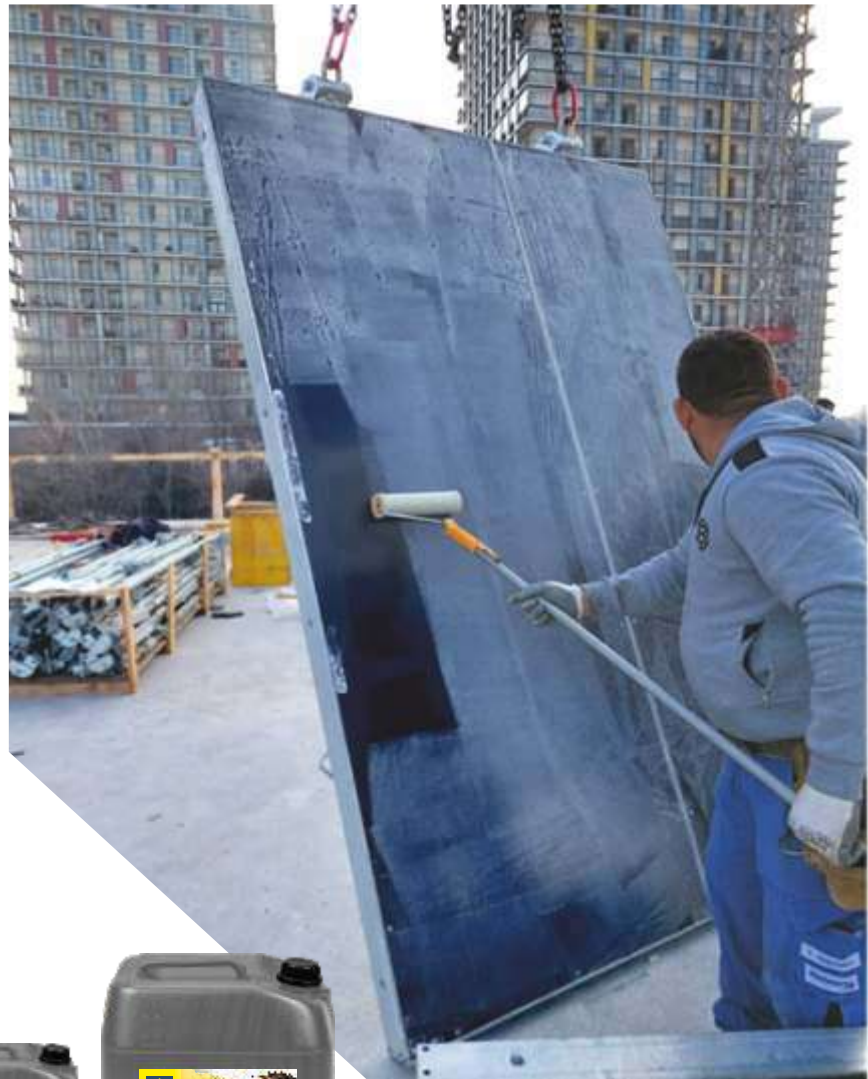

Decofrant soluție **E20**

Emulsie pentru decofrarea betoanelor și pentru tratamentul antiadeziv al tuturor tipurilor de cofraje (tego, metal, plastic, lemn).

- Produsul este pregătit pentru utilizare și se aplică prin pulverizare sau pensulare/roluire.
- **Produsul se diluează în raport 1:1**
- **Consum 2-4 litri diluați/100 mp**
- Ambalaj: bidoan de 10l și 20l



Bidon 10L
COD: RO0009469

16,7 €

Bidon 20L
COD: RO0009470

31,7 €

ELEMENT DE COMPENSARE PENTRU PANOU GALBEN L=62CM, H=53CM
COD: CGCOMPP



SOLICITA OFERTA!

ELEMENT DE COMPENSARE PENTRU PANOU GALBEN L=40/40CM, H=53CM
COD: CGCOMPY



SOLICITA OFERTA!



Popii metalici:

- Sunt fabricați în conformitate cu Standard UNI EN1065;
- Definiție: durabili, siguri, ușor de reglat;
- Popii CONDOR sunt însoțiți de diagramă de sarcină caracteristică.

Accesorii pentru popii

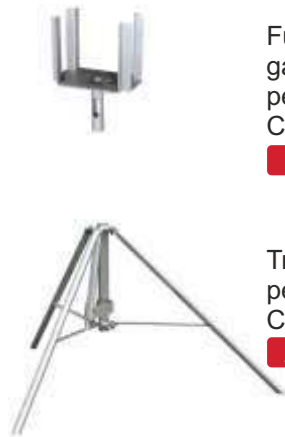

Furcă cruce galvanizată pentru grindă H20
COD: CG0006392

6,0 €

Trepied zincat pentru popii
COD: CG0049005

23,2 €



**DISPONIBIL
ȘI LA
ÎNCHIRIERE**



Specificații tehnice popii metalici galvanizati			
	EK29-3200	EK29-3600	EK29-4000
COD produs	CGEK29-3200	CGEK29-3600	CGEK29-4000
Diametru tub extern	Ø 56 mm		
Diametru tub intern	Ø 48,3 mm		
Lungime min.	1.800 mm	2.000 mm	2.200 mm
Lungime max.	3.200 mm	3.600 mm	4.000 mm
Capacitate kN	29-15,6 kN	29-11,4 kN	29-10,0 kN

15,4 €

16,5 €

17,4 €

Nou!



Specificații tehnice popii metalici vopsiti		
	QS20-4500	QS20-5000
COD produs	CGQS20-4500	CGQS20-5000
Diametru tub extern	Ø 56 mm	
Diametru tub intern	Ø 48,3 mm	
Lungime min.	2.500 mm	2.500 mm
Lungime max.	4.500 mm	5.000 mm
Capacitate kN	20-7,2 kN	20-7,2 kN

17,4 €

18,6 €

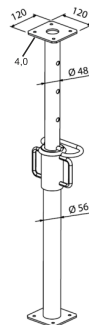

Nou!



Caracteristici:

- Siguranță;
- Manevrabilitate facilă;
- Capacitate ridicată de încărcare;
- Raport optim calitate-preț;
- Calitate superioară;
- Înălțime reglabilă, cu blocaj.



CGA04942/212/T

Sistem mobil EU 2

63,4

Dimensiunea panoului: 3.530 × 2.000 mm
 Diametrul firului: 3 mm orizontal - 2,8 mm vertical
 Dimensiunea ochiului: 100 × 250 mm
 Diametrul tubular: 40 mm orizontal - 27 mm vertical
 Materiale de finisare: țevă și sârmă galvanizate la cald
 Greutate: ~ 12 kg

Caracteristici cheie:

- confectionate din oțel galvanizat
- ranforsare la 4 colturi
- structura rezistentă
- finisaj de calitate superioară
- instalare și manevrare facilă
- siguranță



Ranforsare la 4 colturi.



Clema pentru conexiune superioară cu următorul panou



Inchiriere sistem complet de gard (panou, baza, clema) = 1,45 € (fara TVA) /ml/luna
 Nu include transport.

CGE212/B

Sistem mobil EU 1/B

39,8

Dimensiunea panoului: 3.530 × 2.000 mm
 Diametrul firului: 3,1 mm orizontal - 2,8 mm vertical
 Dimensiunea ochiului: 100 × 250 mm
 Diametrul tubular: 42 mm vertical - 27 mm orizontal
 Materiale de finisare: țevă și sârmă galvanizate la cald
 Greutate: ~ 16,3 kg



CGE212/BIH

Sistem mobil EU 1/BIH

28,8

Nou!

Dimensiunea panoului: 3.300 × 2.000 mm
 Diametrul firului: 3,1 mm orizontal - 2,8 mm vertical
 Dimensiunea ochiului: 100 × 250 mm
 Diametrul tubular: 42 mm vertical - 27 mm orizontal
 Materiale de finisare: țevă și sârmă galvanizate la cald



CGE015

Baza CLS, beton armat, ~ 23 kg

5,7

Cel mai comun suport pentru susținerea gardurilor.
 Realizat din beton cu armare interioară cu sarma de otel adecvata cu aderența îmbunătățită.



CGE019

Clema de conexiune din otel galvanizat

3,5

Este folosit pentru a preveni scoaterea panoului de pe baza de susținere.
 Indispensabil atunci când se utilizează bare de contravântuire.



Cod produs	Descriere produs	Pret Euro (fara TVA)
TE0009460	Tub standard de evacuare 1.060 mm (include lanturi) - Negru	39
TE0009461	Cuva de incarcare standard 650 mm - Negru	65
TE0001119	Tub standard de evacuare 1.060 mm (include lanturi) - Galben	46,0
TE0001120	Cuva de incarcare standard 650 mm - Galben	76,0
TE0007055	Cuva de incarcare prelungita 1.030 mm - Galben	94,0
TE0006226	Cuva de incarcare cu separator - Galben	84,5
TE0001121	Suport pentru cuva de incarcare - Zincat	79,0
TE0006196	Lant complet pentru tubulatura evacuare deseuri (1 bucata)	7,2
TE0006225	Dispozitiv incetinire deseuri	19,5
TEE001LA	Protectie metalica pentru tubulatura	85
TEE001TV	Recipient dreptunghiular din polyuretana cu manere capacitate 180 l	102
TEE001BB	Bena basculanta polietilena 70L/150 kg	89
TEE001IM	Dispozitiv pentru umplerea sacilor	28
TEE001SA	Saci 50x80 cm, 100 micrometri, din polietilena reciclată (set 10 buc.)	5,6

Parapeti rutieri mobili

TE0001711	Parapet lestable NJ60/11 din plastic rosu 1.000x400x600 mm	42
TE0001712	Parapet lestable NJ60/11 din plastic alb 1.000x400x600 mm	37,5
TE0002810	Parapet lestable NJ70/11 din plastic rosu 1.000x400x700 mm	42
TE0002811	Parapet lestable NJ70/11 din plastic alb 1.000x400x700 mm	42



GENERATOARE DE CURENT

SEACI



Generatoare de curent seria Lite
Pagina 96



Generatoare de curent seria Top
Pagina 97



Generatoare de curent seria EVO
Pagina 99



Generatoare tip inverter - COVER
Pagina 100



Generatoare tip inverter - OPEN
Pagina 100



Generatoare pentru sudura
Pagina 101



Generatoare de curent rezidentiale
Pagina 102



Generatoare de curent rezidentiale
Pagina 103



Motopompe
Pagina 104

KOSHIN



Pompe submersibile electrice
Pagina 105

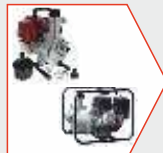

Motopompe ape curate/murdare
Pagina 106

FRIGGERI



Aparataj electric
Pagina 108



Cod produs	Descriere produs	Pret Euro (fara TVA)	
6426390839053	SC-1250 LITE Putere max. 1,0kW, 230V-50Hz, Motor benzina 3 cp Rezervor carburant 6L; Autonomie 12,5 ore - 1/2 incarcare/consum Contor ore/voltmetru/frecventa; Senzor lipsa ulei cu led rosu si oprire motor Greutate: 26kg; Dimensiuni: 510x390x450mm	216	
6426390839060	SC-1250E LITE Idem, pornire electrica, baterie inclusa	260	
6426390839237	SC-2500 LITE Putere max. 2,2kW, 230V-50Hz, Motor benzina 5,5 cp Rezervor carburant 15L; Autonomie 12,5 ore - 1/2 incarcare/consum Contor ore/voltmetru/frecventa; Senzor lipsa ulei cu led rosu si oprire motor Greutate: 42kg; Dimensiuni: 625x490x510mm	263	
6426390839251	SC-3500 LITE Putere max. 3,1kW, 230V-50Hz, Motor benzina 7 cp Rezervor carburant 15L; Autonomie 12,5 ore - 1/2 incarcare/consum Contor ore/voltmetru/frecventa; Senzor lipsa ulei cu led rosu si oprire motor Greutate: 48kg; Dimensiuni: 625x480x500mm	298	
6426390839268	SC-3500E LITE , idem, pornire electrica, baterie inclusa	340	
6426390839282	SC-4000 LITE Putere max. 3,8kW, 230V-50Hz, Motor benzina 7,5 cp Rezervor carburant 15L; Autonomie 13,5 ore - 1/2 incarcare consum Contor ore/voltmetru/frecventa; Senzor lipsa ulei cu led rosu si oprire motor Greutate: 50kg; Dimensiuni: 625x490x510mm	363	
6426390839350	SC-6000 LITE Putere max. 5,5kW, 230V-50Hz, Motor benzina 13 cp Rezervor carburant 25L; Autonomie 13,5 ore - 1/2 incarcare consum Contor ore/voltmetru/frecventa; Senzor lipsa ulei cu led rosu si oprire motor Greutate: 81kg; Dimensiuni: 730x556x610mm	523	
6426390839381	SC-9000E LITE , Putere max. 7,5 kW, 230V-50Hz, Motor benzina 16 cp Rezervor carburant 25 l; Autonomie 10,5 ore - 1/2 incarcare consum Contor ore/voltmetru/frecventa, demaraj electric (acumulator inclus) Senzor lipsa ulei cu led rosu si oprire motor Roti si manere pentru transport incluse Greutate: 90kg; Dimensiuni: 686x526x550mm	700	

Cod produs	Descriere produs	Pret Euro (fara TVA)
6426390839220	SC-2500 TOP Putere max. 2,2kW, 230V-50Hz, Motor benzina 5,5 cp Rezervor carburant 15L Autonomie 12,5 ore - 1/2incarcare/consum Contor ore/voltmetru/frecventa Senzor lipsa ulei cu led rosu si oprire motor Greutate: 42kg; Dimensiuni: 625x490x510mm	299
6426390839244	SC-3500 TOP Putere max. 3,1kW, 230V-50Hz, Motor benzina 7 cp Rezervor carburant 15L Autonomie 12,5 ore - 1/2incarcare/consum Contor ore/voltmetru/frecventa Senzor lipsa ulei cu led rosu si oprire motor Greutate: 48kg; Dimensiuni: 625x480x500mm	346
6426390839275	SC-4000 TOP Putere max. 3,8kW, 230V-50Hz, Motor benzina 7,5 cp Rezervor carburant 15L Autonomie 13,5 ore - 1/2incarcare consum Contor ore/voltmetru/frecventa Senzor lipsa ulei cu led rosu si oprire motor Greutate: 50kg; Dimensiuni: 625x490x510mm	398
6426390839312	SC-5000 TOP Putere max. 4,5kW, 230V-50Hz, Motor benzina 11 cp Rezervor carburant 25L Autonomie 13,5 ore - 1/2incarcare consum Contor ore/voltmetru/frecventa Senzor lipsa ulei cu led rosu si oprire motor Roti si manere pentru un transport facil Greutate: 78kg; Dimensiuni: 730x556x610mm	582
6426390839329	SC-5000E TOP - idem SC-5000, demaraj electric, acumulator inclus 	661
6426390839343	SC-6000 TOP Putere max. 5,5kW , 230V-50Hz , Motor benzina 13 cp Rezervor carburant 25L Autonomie 13,5 ore - 1/2incarcare consum Contor ore/voltmetru/frecventa Senzor lipsa ulei cu led rosu si oprire motor Roti si manere pentru un transport facil Greutate: 81kg; Dimensiuni: 730x556x610mm	604
6426390839367	SC-6000E TOP - idem SC-6000, demaraj electric, acumulator inclus 	684
BT0004370	Ulei motor pe benzina, Italia Star 10W-40 fabricat in Romania, bidon 1L	5,4



Cod produs

Descriere produs

Pret Euro (fara TVA)

6426390839428

SC-8000E TOP Putere max. 7kW, 230V-50Hz - Motor benzina 14 cp

718



Rezervor carburant 25L; Autonomie 12,5 ore - 1/2 incarcare consum
Contor ore/voltmetru/frecventa, demaraj electric (acumulator inclus)
 Senzor lipsa ulei cu led rosu si oprire motor
 Roti si manere pentru transport incluse
 Greutate: 88kg; Dimensiuni: 730x556x610mm



6426390839435

SC-8000TE TOP Putere max. 7 kW-400V / 2.3kW-230V - Motor benzina 14cp

781



Rezervor carburant 25L; Autonomie 12,5 ore - 1/2 incarcare consum
Contor ore/voltmetru/frecventa, demaraj electric (acumulator inclus)
 Senzor lipsa ulei cu led rosu si oprire motor
 Roti si manere pentru transport incluse
 Greutate: 88kg; Dimensiuni: 730x556x610mm



6426390839022

SC-10000E TOP Putere max. 8,5kW , 230V-50Hz - Motor benzina 16 cp

800



Rezervor carburant 25L; Autonomie 12,5 ore - 1/2 incarcare consum
Contor ore/voltmetru/frecventa, demaraj electric (acumulator inclus)
 Senzor lipsa ulei cu led rosu si oprire motor
 Roti si manere pentru transport incluse
 Greutate: 94kg; Dimensiuni: 730x556x610mm



6426390839046

SC-10000TE TOP Putere max.8,5kW-400V sau 2,8kW-230V - Motor 16 cp

863



Rezervor carburant 25L; Autonomie 12,5 ore - 1/2 incarcare consum
Contor ore/voltmetru/frecventa, demaraj electric (acumulator inclus)
 Senzor lipsa ulei cu led rosu si oprire motor
 Roti si manere pentru transport incluse
 Greutate: 94kg; Dimensiuni: 730x556x610mm



6426390839404

SC-8000-ATS TOP Putere max. 7 kW, 230V-50Hz, Motor benzina 14 cp

846



Rezervor carburant 25L; Autonomie 13 ore - 1/2 incarcare/consum
ATS si AVR inclus, contor ore/voltmetru/frecventa
 Senzor lipsa ulei cu led rosu si oprire motor
 Greutate: 88kg; Dimensiuni: 730x556x610mm



6426390839039

SC-10000E-ATS TOP Putere max. 8,5kW, 230V-50Hz - Motor benzina 16 cp

928



Rezervor carburant 25L; Autonomie 12,5 ore - 1/2 incarcare consum
ATS si AVR inclus Contor ore/voltmetru/frecventa, demaraj electric
 Senzor lipsa ulei cu led rosu si oprire motor
 Roti si manere pentru transport incluse
 Greutate: 94kg; Dimensiuni: 730x556x610mm



SC1008604	SC-13000-EVO Putere max. 11kW, 230V-50Hz Motor benzina 20 cp Rezervor carburant 45L; Autonomie 13 ore - 1/2 incarcare/consum AVR inclus , conectivitate ATS, contor ore/voltmetru/frecventa Roti si baterie incluse; Senzor lipsa ulei cu led rosu si oprire motor Greutate: 170 kg; Dimensiuni: 730x770x915mm	2.160	
6426390839091	SC-13000-EVO-ATS , idem SC-13000-EVO, ATS inclus	2.187	
SC1008603	SC-13000TEQ-EVO , idem SC-13000-EVO Putere max. 11kW, 400V si 230V - 50Hz	2.070	
6426390839138	SC-13000TEQ-EVO-ATS , idem SC-13000TEQ-EVO, ATS inclus	2.475	
SC1008601	Panou ATS 13000 230V	327	
SC1008599	Panou ATS 13000TEQ 400V si 230V	327	
SC1008602	SC-15000-EVO Putere max. 13kW - 230V-50Hz Motor benzina 22 cp Rezervor carburant 45L; Autonomie 13 ore - 1/2 incarcare consum AVR inclus , conectivitate ATS, contor ore/voltmetru/frecventa Roti si baterie incluse; Senzor lipsa ulei cu led rosu si oprire motor Greutate: 190 kg; Dimensiuni: 770x770x935 mm	2.599	
6426390839145	SC-15000EVO-ATS , idem SC-15000-EVO, ATS inclus	2.792	
SC1008600	SC-15000TE-EVO idem SC-15000-EVO, Putere max. 13 kW, 16 kVA - 400V	2.675	
6426390839152	SC-15000TE-EVO-ATS idem SC-15000TE-EVO, ATS inclus	2.909	
SC1008601	Panou ATS 15000 230V	327	
SC1008599	Panou ATS 15000TE 400V	327	
SC1008598	SC-18000-EVO , Putere max. 17 kW - 230V - 50Hz Motor benzina 33 cp Rezervor carburant 45L; Autonomie 10 ore - 1/2 incarcare consum AVR inclus , conectivitate ATS, contor ore/voltmetru/frecventa Roti si baterie incluse; Senzor lipsa ulei cu led rosu si oprire motor Greutate: 230 kg; Dimensiuni: 900x790x985 mm	3.850	
6426390839169	SC-18000-EVO-ATS , idem SC-18000-EVO, ATS inclus	3.983	
SC1008596	SC-18000TE-EVO , idem SC-18000-EVO, Putere max. 17 kW, 21 kVA - 400V	3.865	
6426390839176	SC-18000TE-EVO-ATS , idem SC-18000TE-EVO, ATS inclus	4.100	
SC1008597	Panou ATS 18000 230V	327	
SC1008595	Panou ATS 18000TE 400V	327	

Cod produs	Descriere produs	Pret Euro (fara TVA)
SC1009406	SC-1400i Putere max. 1,2 kW, 230V-50Hz , Motor Senci SH60B 60cc Rezervor carburant 2L tehnologie alternator tip INVERTER- SENCi Senzor lipsa ulei cu led rosu si oprire motor, insonorizat doar 59 dB Autonomie 50%-100% sarcina 4,5/2,5 ore Greutate: 12kg; Dimensiuni: 430x252x400mm	261
SC1009556	SC1700i Putere maxima 1.7 kW 230V-50Hz , Motor benzina SH80C, 79,7cc, Rezervor carburant 3,5 l; tehnologie alternator tip INVERTER- SENCi; Senzor lipsa ulei cu led rosu si oprire motor, insonorizat doar 59 dB Autonomie 50%-100% 6-3,5 ore Greutate: 15 kg; Dimensiuni: 470x279x400mm	307
6426390839190	SC-2000is Putere max. 1,8 kW, 230V-50Hz , Motor benzina Senci SC80, 79cc Rezervor carburant 4L tehnologie alternator tip INVERTER- SENCi Senzor lipsa ulei cu led rosu si oprire motor, insonorizat doar 60 dB Autonomie 6,8 ore - 1/2 incarcare consum Greutate: 22kg; Dimensiuni: 540x330x505mm	504
6426390839183	SC-2000i Putere max. 1,8 kW, 230V-50Hz , Motor benzina YAMAHA 79cc Rezervor carburant 4L tehnologie alternator tip INVERTER- SENCi Senzor lipsa ulei cu led rosu si oprire motor, insonorizat doar 50dB Autonomie 6,8 ore - 1/2 incarcare consum Greutate: 20kg; Dimensiuni: 540x330x505mm	763
SC1009557	SC2300i-O Putere max. 2,1 kW, 230V-50Hz Motor benzina SH80C, 80cc, Rezervor carburant 4,0 l; tehnologie alternator tip INVERTER- SENCi; Senzor lipsa ulei cu led rosu si oprire motor, insonorizat doar 60 dB Autonomie 50%-100% 6-4 ore Greutate: 23 kg; Dimensiuni: 560x360x530 mm	390
6426390839886	SC-4000iE-O Putere max. 3,8 kW, 230V , motor benzina Senci 223cc Rezervor carburant 10 l tehnologie alternator tip INVERTER- SENCi Senzor lipsa ulei cu led rosu si oprire motor, insonorizat doar 58dB Autonomie 8ore - 1/2 incarcare consum Greutate: 51kg; Dimensiuni: 605x488x560 mm 2 telecomenzi - utilizare la 50m spatii deschise si la 15m in spatii cu obstacole	820
6426390839299	SC-4000i Putere max. 4 kW, 230V , motor benzina Senci 223cc Rezervor carburant 13,2 l tehnologie alternator tip INVERTER- SENCi Senzor lipsa ulei cu led rosu si oprire motor, insonorizat doar 58dB Autonomie 13,4ore - 1/2 incarcare consum Greutate: 57kg; Dimensiuni: 690x460x500 mm	811
BT0004370	Ulei pentru motor pe benzina, Italia Star 10W40 fabricat in Romania	5,4



Cod produs	Descriere produs	Pret Euro (fara TVA)
3161304182469	SC-5500iE Putere max. 6 kW, 230V-50Hz , Motor Senci SV320B 320cc Rezervor carburant 13,5L tehnologie alternator tip INVERTER- SENCi Senzor lipsa ulei cu led rosu si oprire motor, insonorizat doar 64dB Autonomie 50%-100% sarcina 11/4,5 ore. Optiune adaugare ATS Greutate: 57,5kg; Dimensiuni: 630x480x540mm; 2 telecomenzi - utilizare la 50m spatii deschise si la 15m in spatii cu obstacole	947
3161304182483	SC-8000i Putere max. 7,5 kW, 230V-50Hz , Motor Senci SC460 459cc Rezervor carburant 26L tehnologie alternator tip INVERTER- SENCi Senzor lipsa ulei cu led rosu si oprire motor, insonorizat doar 67dB Autonomie 50%-100% sarcina 11/6 ore. Optiune adaugare ATS Greutate: 115kg; Dimensiuni: 820x640x780mm 2 telecomenzi - utilizare la 50m spatii deschise si la 15m in spatii cu obstacole	1.786
SC1009409	SC-15000i Putere max. 13 kW, 230V-50Hz , Motor Senci SV750 744cc Rezervor carburant 40L tehnologie alternator tip INVERTER- SENCi Senzor lipsa ulei cu led rosu si oprire motor, insonorizat doar 75dB Autonomie 50%-100% sarcina 11/5 ore. Optiune adaugare ATS Greutate: 170kg; Dimensiuni: 972x783x873mm	4.070
Generatoare tip inverter - OPEN		
6426390839008	SC-3200iFE Putere max. 3,2 kW, 230V , motor benzina Senci 208cc Rezervor carburant 15 l tehnologie alternator tip INVERTER- SENCi Autonomie 12 ore - 1/2 incarcare consum Greutate 34 kg; Dimensiuni: 565x442x468 mm	393
6426390839015	SC-4200iFE Putere max. 4,2 kW, 230V , motor benzina Senci 223cc Rezervor carburant 15 l tehnologie alternator tip INVERTER- SENCi Autonomie 11 ore - 1/2 incarcare consum Greutate 42 kg; Dimensiuni 557x464x478	547
BT0004370	Ulei pentru motor pe benzina, Italia Star 10W40 fabricat in Romania	5,4



Multifuncțional 4 în 1

SC1008395

SC200BF Generator, Sudura, Compresor si Taietor cu plasma

1.579

Generator: Putere max. 7,5 kW / 230V 50 Hz; Demaraj electric si la sfoară;
Carburant benzina; Capacitate rezervor carburant: 30 L;
Sudură: Tensiune fără sarcină DC 75V; Tensiune de funcționare SC 22-26.8V;
Interval amperaj 50-170A; Curent nominal 160A/26.4V;
Compresor: Putere 1,35 kW/220V; Capacitate rezervor aer 20L;
Debit la 90 bar 125 l/min.; Presiune max.115 bar;
Tăiere cu plasmă: Tensiune fără sarcină DC 230V; Interval curent 10-40A;
Curent nominal 35A; Grosime tăiere 1-10mm.



Generator diesel open

6426390839411

SC-8000DE Generator diesel open

1.026



Putere max. 7 kW, 230V-50Hz;
Motor diesel, demaraj electric, rezervor combustibil 18 l;
Set roti si manere incluse pentru transport;
Greutate: 117 kg; Dimensiuni LxIxh (mm) 795x540x625 mm.



Generatoare pentru curent si sudura

6426390839206

SC-200A Generator pentru curent si sudura

1.156



Putere max. 5,5 kW, 230V / 50 Hz;
Motor benzina, demaraj electric, rezervor carburant 18 l;
Amperaj sudura 50 - 200 A; Tip electrod 1,6 - 5 mm;
AVR inclus, contor ore/voltmetru/frecventa;
Sensor lipsa ulei cu led rosu si oprire motor;
Set roti si manere incluse pentru transport;
Greutate: 99 kg; Dimensiuni: 780x545x632mm.



SC1009326 **SC-300** Generator pentru curent si sudura

2.505



Putere max. 3,5 kW, 230V / 50 Hz;
Motor benzina, demaraj electric, rezervor carburant 18 l;
Amperaj sudura 50 - 300 A; Tip electrod 1,6 - 6 mm;
AVR inclus, contor ore/voltmetru/frecventa;
Sensor lipsa ulei cu led rosu si oprire motor;
Set roti si manere incluse pentru transport;
Greutate: 130 kg; Dimensiuni: 895x554x585mm.



SC1009327 **SC-300XL** Generator pentru curent si sudura

2.711

Putere max. 3,5 kW, 230V / 50 Hz;
Motor benzina, demaraj electric, rezervor carburant 45 l;
Amperaj sudura 50 - 300 A; Tip electrod 1,6 - 6 mm;
AVR inclus, contor ore/voltmetru/frecventa;
Sensor lipsa ulei cu led rosu si oprire motor;
Set roti si manere incluse pentru transport;
Greutate: 150 kg; Dimensiuni: 730x600x975mm.



BT0004370 Ulei pentru motor pe benzina, Italia Star 10W40 fabricat in Romania

5,4

Cod produs

Descriere produs

Pret Euro (fara TVA)

6426390839398



SC-7500Q Generator insonorizat diesel - **ATS si AVR inclus**

1.181

Putere max. 6 kW, 230V-50Hz, demaraj electric, rezervor 18 l
Greutate: 170 kg; Dimensiuni: LxIxh 960x560x770 mm



3161304182322



SC-7500Q-3 Generator insonorizat diesel trifazat - **ATS si AVR inclus**

1.365

Putere max. 400V: 6 kVA / 4,8 kW, Putere max. 230V: 1,6 kW, Putere in regim continuu: 5 kVA / 4 kW, demaraj electric, rezervor 18 l
Greutate: 164 kg; Dimensiuni: LxIxh 960x560x770 mm



SC1009324



SC-10000Q Generator insonorizat diesel - **ATS si AVR inclus**

1.705

Putere max. 8 kW
Putere in regim continuu 7,5 kW
230V-50Hz
Demaraj electric, rezervor 18 l
Greutate: 185 kg; Dimensiuni: LxIxh 1.045x565x815 mm



3161304182476



SC-10000Q-3 Generator insonorizat diesel trifazat - **ATS si AVR inclus**

1.740

Putere max. / in regim continuu 400V: 8 kW / 7,5 kW
Putere max. / in regim continuu 230V: 2,7 kW / 2,5 kW
Demaraj electric, rezervor 18 l
Greutate: 185 kg; Dimensiuni: LxIxh 1.045x565x815 mm



Interior captusit cu burete fonoabsorbant din spuma poliuretantica flexibila pentru o izolare fonica sporita

SC1009398



SCD13000Q-ATS Generator insonorizat diesel - **ATS si AVR inclus**

3.088

Putere max. 11 kVA
Putere in regim continuu 10 kVA
230V-50Hz
Demaraj electric, rezervor 26 l
Greutate: 250 kg; Dimensiuni: LxIxh 1.045x565x815 mm



SC1009399



SCD13000Q-3-ATS Generator insonorizat diesel trifazat - **ATS si AVR inclus**

3.075

Putere max. / in regim continuu 400V: 11 kVA
Putere max. / in regim continuu 230V: 11 kVA
Demaraj electric, rezervor 26 l
Greutate: 250 kg; Dimensiuni: LxIxh 1.045x565x815 mm



NOU!

Toate generatoarele sunt configurate standard cu controller DC5x-4G de ultima generatie cu:

- Modul de comunicatii la distanta GPRS, inclusiv GPS
- Protectie cu parola maxim 40 de caractere
- Rata de comunicare CAN pana la 500 Kbps
- Configurabil inclusiv pentru pornire de la distanta si plan de lucru orar/zilnic/lunar.



Toate generatoarele din gama SCDE includ panou ATS

SC1009380 **SCDE 19i-YS** Generator insonorizat diesel - **ATS si AVR inclus** 5.536



Putere max. **19 kVA**, 400V - 50 Hz, demaraj electric, rezervor 80 l
Greutate: 650 kg; Dimensiuni: Lxlxh 1.950x900x1.050 mm

SC1007701 **SCDE 19YSM** Generator insonorizat diesel - **ATS si AVR inclus** 5.526



Putere max. **19 kVA**, 230V - 50 Hz, demaraj electric, rezervor 80 l
Greutate: 650 kg; Dimensiuni: Lxlxh 1.950x900x1.050 mm

SC1009381 **SCDE 25i-YS** Generator insonorizat diesel - **ATS si AVR inclus** 5.845



Putere max. **25 kVA**, 400V - 50 Hz, demaraj electric, rezervor 86 l
Greutate: 669 kg; Dimensiuni: Lxlxh 1.950x900x1.050 mm

SC1009404 **SCDE 34i-YS** Generator insonorizat diesel - **ATS si AVR inclus** 6.974



Putere max. **34 kVA**, 400V - 50 Hz, demaraj electric, rezervor 100 l
Greutate: 971 kg; Dimensiuni: Lxlxh 2.250x1.000x1.250 mm

SC1009382 **SCDEi-55i-S** Generator insonorizat diesel - **ATS si AVR inclus** 8.392



Putere max. **55 kVA**, 400V - 50 Hz, demaraj electric, rezervor 100 l
Greutate: 1.030 kg; Dimensiuni: Lxlxh 2.250x1.000x1.250 mm

SC1009405 **SCDE 72i-YS** Generator insonorizat diesel - **ATS si AVR inclus** 10.268



Putere max. **72 kVA**, 400V - 50 Hz, demaraj electric, rezervor 130 l
Greutate: 1.194 kg; Dimensiuni: Lxlxh 2.400x1.000x1.250 mm

SC1009383 **SCDE 97i-YS** Generator insonorizat diesel - **ATS si AVR inclus** 12.697



Putere max. **97 kVA**, 400V - 50 Hz, demaraj electric, rezervor 140 l
Greutate: 1.400 kg; Dimensiuni: Lxlxh 2.400x1.000x1.250 mm

SC1009400 **SCDE 125i-YCS** Generator insonorizat diesel; **ATS si AVR inclus** 15.677



Putere max. **125 kVA**, 400V, demaraj electric, rezervor 340 l
Greutate: 1.600 kg; Dimensiuni: Lxlxh 3.000x1.100x1.160 mm

SC1009401 **SCDE 162i-YCS** Generator insonorizat diesel; **ATS si AVR inclus** 19.482



Putere max. **162 kVA**, 400V, demaraj electric, rezervor 340 l
Greutate: 2.100 kg; Dimensiuni: Lxlxh 3.300x1.300x1.820 mm

SC1009402 **SCDE 187i-YCS** Generator insonorizat diesel; **ATS si AVR inclus** 20.133



Putere max. **190 kVA**, 400V, demaraj electric, rezervor 420 l
Greutate: 2.300 kg; Dimensiuni: Lxlxh 3.300x1.300x1.820 mm

SC1009384 **SCDE 250i-YCS** Generator insonorizat diesel; **ATS si AVR inclus** 23.481



Putere max. **250 kVA**, 400V, demaraj electric, rezervor 420 l
Greutate: 2.750 kg; Dimensiuni: Lxlxh 4.000x1.800x2.150 mm

SC1009403 **SCDE 312i-YCS** Generator insonorizat diesel; **ATS si AVR inclus** 27.184



















Putere max. **312 kVA**, 400V, demaraj electric, rezervor 500 l
Greutate: 3.000 kg; Dimensiuni: Lxlxh 4.000x1.800x2.150 mm



Cod produs	Descriere produs	Pret Euro (fara TVA)
6426390839527	SCWP-25 Motopompa pentru ape curate cu diam. 1" - 25mm Motor 3 cp-98CC, Rezervor carburant 1,6L Debit: 6m ³ /ora - 100L/min Adancime 8m - distanta de refulare 18m Senzor lipsa ulei cu led rosu si oprire motor Greutate: 16kg; Dimensiuni: 420x350x375mm	135
6426390839534	SCWP-50 Motopompa pentru ape curate cu diam. 2" - 50mm Motor 7 cp-208CC, Rezervor carburant 3,6L Debit: 30m ³ /ora - 500L/min Senzor lipsa ulei cu led rosu si oprire motor Greutate: 26kg; Dimensiuni: 490x405x400mm	153
6426390839541	SCWP-80 Motopompa pentru ape curate cu diam. 3" - 80mm Motor 7,5 cp-223CC, Rezervor carburant 3,6L Debit: 60m ³ /ora - 1.000L/min Adancime 8m - distanta de refulare 30m Senzor lipsa ulei cu led rosu si oprire motor Greutate: 28,5kg; Dimensiuni: 520x405x415mm	170
6426390839558	SCWP-80E Motopompa pentru ape curate cu diam. 3" - 80mm Motor 7,5 cp-223CC, Rezervor carburant 11,3L, demaraj electric Debit: 60m ³ /ora - 1.000L/min Adancime 8m - distanta de refulare 30m Senzor lipsa ulei cu led rosu si oprire motor Greutate: 28,5kg; Dimensiuni: 520x405x415mm	294
6426390839510	SCWP-100A Motopompa pentru ape curate cu diam. 4" - 100mm Motor 7,5 cp-223CC, Rezervor carburant 3,6L Debit: 80m ³ /ora - 1.330L/min Adancime 8m - distanta de refulare 25m Senzor lipsa ulei cu led rosu si oprire motor Greutate: 40kg; Dimensiuni: 680x465x545mm	217
6426390839572	SCWT-80 Motopompa pentru ape murdare cu diam. 3" - 80mm Motor 7,5 cp-223CC, Rezervor carburant 3,6L Debit: 65m ³ /ora - 1.100L/min Adancime 8m - distanta de refulare 28m Senzor lipsa ulei cu led rosu si oprire motor Greutate: 38kg; Dimensiuni: 580x450x440mm	249
6426390839589	SCWT-80E Motopompa pentru ape murdare cu diam. 3" - 80mm Motor 7,5 cp-223CC, Rezervor carburant 3,6L, demaraj electric Debit: 65m ³ /ora - 1.100L/min Adancime 8m - distanta de refulare 28m Senzor lipsa ulei cu led rosu si oprire motor Greutate: 38kg; Dimensiuni: 580x450x440mm	340
6426390839565	SCWT-100 Motopompa pentru ape murdare cu diam. 4" - 100mm Motor 13 cp Rezervor carburant 6,5L Debit: 99m ³ /ora - 1.650L/min Adancime 8m - distanta de refulare 28m Senzor lipsa ulei cu led rosu si oprire motor Greutate: 42kg; Dimensiuni: 580x480x470mm	390
6426390839503	SCPW-2700 Echipament pentru spalare cu presiune - 7,9 l/min. Motor Senci 6,5 cp, rezervor combustibil 3,5 l Debit apa: 7,9 l/min. presiune de lucru 165 bar Greutate: 28 kg; Dimensiuni 590x540x595 mm	365



Cod produs	Descriere produs	Pret Euro (fara TVA)	
Pompe electrice pentru drenaj ape reziduale - SERIA PONSTAR			
4971770430860	Pompa submersibila KOSHIN PXL-52522-BAC motor electric 220V 540W Ø 25 mm debit 7.2 mc/h, granulometrie 6 mm	230	
	(Nou!)		
4971770430839	Pompa submersibila KOSHIN PX-55022-BAC motor electric 220V, 620W Ø 50 mm debit 15.5 mc/h, granulometrie 6 mm	208	
	(Nou!)		
Pompe electrice pentru drenaj ape reziduale - SERIA DEWATERING			
4971770770010	Pompa submersibila KOSHIN PXJ-150-BAB motor electric 220V/150W Ø 15-20-25 mm debit 5.7 mc/h, granulometrie 1 mm	123	
	(Nou!)		
4971770770027	Pompa submersibila KOSHIN PXJ-250-BAB motor electric 220V 250W, Ø 40 mm debit 11.4 mc/h, granulometrie 6 mm, corp pompa inox	241	
	(Nou!)		
KSPXJ-400-BAB	Pompa submersibila KOSHIN PXJ-400-BAB motor electric 220V 400W Ø 50 mm debit 11.7 mc/h, granulometrie 6 mm, corp pompa inox	262	
	(Nou!)		
4971770770041	Pompa submersibila KOSHIN PXJ-750-BAB motor electric 220V 750W Ø 50 mm debit 19.5 mc/h, granulometrie 6 mm, corp pompa inox	466	
	(Nou!)		
Pompe electrice pentru ape murdare - SERIA VORTEX *includ Impeller (roata centrifugala cu palete)			
4971770770058	Pompa submersibila Vortex KOSHIN PKJ-150-BAB motor electric 220V, 150W Ø 32 mm debit 9 mc/h, granulometrie pana la 10 mm	140	
	(Nou!)		
4971770770065	Pompa submersibila Vortex KOSHIN PKJ-250-BAB motor electric 220V 250W, Ø 40 mm debit 13.5 mc/h, granulometrie pana la 30 mm	214	
	(Nou!)		
4971770770072	Pompa submersibila Vortex KOSHIN PKJ-400-BAB motor electric 220V 400W Ø 50 mm debit 14.7 mc/h, granulometrie pana la 30 mm	241	
	(Nou!)		
4971770770089	Pompa submersibila Vortex KOSHIN PKJ-750-BAB motor electric 220V 750W Ø 50 mm debit 20.4 mc/h, granulometrie pana la 30 mm	447	
	(Nou!)		
4971770770096	Pompa submersibila Vortex KOSHIN PKJ-1500-BAB motor electric 220V 1500W Ø 80 mm debit 40.8 mc/h, granulometrie pana la 30 mm	668	
	(Nou!)		
Pompe electrice cu tocator pentru deseuri organice - SERIA GRINDER			
4971770770102	Pompa submersibila Grinder KOSHIN PKG-750-BAB motor electric 220V 750W Ø 32 mm debit 10.5 mc/h	651	
	(Nou!)		
4971770770119	Pompa submersibila Grinder KOSHIN PKG-1200-BAB motor electric 220V 1200W Ø 32 mm debit 10.8 mc/h	744	
	(Nou!)		
4971770770126	Pompa submersibila Grinder KOSHIN PKG-1500-BAB motor electric 220V 1500W Ø 32 mm debit 10.8 mc/h	931	
	(Nou!)		

Cod produs	Descriere produs	Pret Euro (fara TVA)	
Motopompe ape curate - seria SEV			
4971770126190	Motopompa ape curate KOSHIN SEV-25L-BAC motor Koshin KC26 Ø 25 mm debit 6.6 mc/h	187	
	(Nou!)		
4971770127074	Motopompa ape curate KOSHIN SEV-25F-BAB motor Koshin KC35 Ø 25 mm debit 8 mc/h	240	
	(Nou!)		
4971770125988	Motopompa ape curate KOSHIN SEV-50X-BAE motor Koshin K180 Ø 50 mm debit 37 mc/h	245	
	(Nou!)		
4971770126022	Motopompa ape curate KOSHIN SEV-80X-BAC motor Koshin K180 Ø 80 mm debit 63 mc/h	275	
	(Nou!)		
4971770129764	Motopompa ape curate KOSHIN SEV-100X-BAE motor Koshin K300 Ø 100 mm debit 90 mc/h	719	
	(Nou!)		
Motopompe ape semimurdare - seria STV			
4971770126213	Motopompa ape semimurdare KOSHIN STV-50X-BAA motor Koshin K180 Ø 50 mm debit 34 mc/h	322	
	(Nou!)		
4971770126220	Motopompa ape semimurdare KOSHIN STV-80X-BAA motor Koshin K180 Ø 80 mm debit 54 mc/h	355	
	(Nou!)		
4971770129771	Motopompa ape semimurdare KOSHIN STV-100X-BAE motor Koshin K300 Ø 100 mm debit 90 mc/h	830	
	(Nou!)		
Motopompe ape foarte murdare - seria KTZ			
4971770129788	Motopompa ape foarte murdare KOSHIN KTZ-50X-BAE motor Koshin K180 Ø 50 mm debit 41 mc/h	624	
	(Nou!)		
4971770129797	Motopompa ape foarte murdare KOSHIN KTZ-80X-BAE motor Koshin K300 Ø 80 mm debit 82 mc/h	835	
	(Nou!)		
4971770129807	Motopompa ape foarte murdare KOSHIN KTZ-100X-BAE motor Koshin K420 Ø 100 mm debit 101 mc/h	1.287	
	(Nou!)		
Motopompe de inalta presiune - seria SERV			
KSSERV-50Z-BA	Motopompa de inalta presiune KOSHIN SERV-50Z-BAB-0 motor Koshin Ø 50 mm debit 29 mc/h	618	
	(Nou!)		

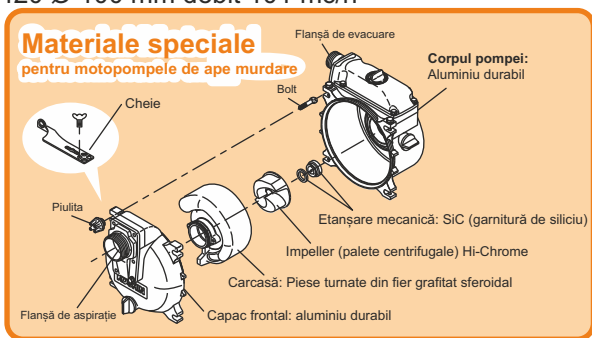

Cod produs	Descriere produs	Pret Euro (fara TVA)
Motopompe ape curate - seria SEH		
4971770123519	Motopompa ape curate KOSHIN SEH-25H-BAD motor Honda GXH50 Ø 25 mm debit 8.1 mc/h	336
4971770123328	Motopompa ape curate KOSHIN SEH-25L-BAA motor Honda GX25 Ø 25 mm debit 6.9 mc/h	255
4971770111011	Motopompa ape curate KOSHIN SEH-50X-BBB , motor Honda GX120, Ø 50 mm, debit 38 mc/h	367
4971770111004	Motopompa ape curate KOSHIN SEH-80X-BAS motor Honda GX160 Ø 80 mm debit 66 mc/h	408
4971770121768	Motopompa ape curate KOSHIN SEH-100X-BAE motor Honda GX240 Ø 100 mm debit 87 mc/h	893
Motopompe pentru ape semimurdare - seria STH		
4971770113299	Motopompa ape semimurdare KOSHIN STH-50X-BCO motor Honda GX120 Ø 50 mm debit 36 mc/h	416
4971770123625	Motopompa ape semimurdare KOSHIN STH-80X-BDW motor Honda GX160 Ø 80 mm debit 54 mc/h	461
Motopompe pentru ape foarte murdare - seria KTH		
4971770120693	Motopompa ape foarte murdare KOSHIN KTH-50X-BAB motor Honda GX160 Ø 50 mm debit 42 mc/h	714
4971770120709	Motopompa ape foarte murdare KOSHIN KTH-80X-BAB motor Honda GX240 Ø 80 mm debit 80 mc/h	1.024
4971770122789	Motopompa ape foarte murdare KOSHIN KTH-100X-BAF motor Honda GX340 Ø100 mm debit 99 mc/h	1.456
Motopompe pentru ape sarate si fertilizatori - seria PGH		
4971770130128	Motopompa termoplastica pentru ape sarate si fertilizatori KOSHIN PGH-50-BAG motor Honda GX120 Ø 50 mm debit 33.5 mc/h	451
Motopompe de inalta presiune - seria SERH		
4971770127395	Motopompa de inalta presiune KOSHIN SERH-50V-BAA motor Honda GX160HR Ø 50 mm debit 26 mc/h	627
4971770129177	Motopompa de inalta presiune KOSHIN SERH-50Z-BAA motor Honda GX200HR Ø 50 mm debit 30 mc/h	663



Priza cu capac
 COD: EFFR-P316

Montarea mânerului cu dispozitiv de fixare rapidă
 Cablu strâns cu inel anti-desuruburi
 Rezistență bună la temperaturi ridicate și scăzute
 Aparat de conectare rapidă fără șuruburi Wives



 În conformitate cu CEI EN 60309-1-2







3,7 €

Priza cu capac
 COD: EFFR-P53267

Montarea mânerului cu dispozitiv de fixare rapidă
 Cablu strâns cu inel anti-desuruburi
 Rezistență bună la temperaturi ridicate și scăzute
 Aparat de conectare rapidă fără șuruburi Wives



 În conformitate cu CEI EN 60309-1-2







16,8 €

Adaptor stecher Schuko si priza
 COD: EFFR-17024D



 În conformitate cu CEI EN 60309-1-2













7,9 €



Adaptor stecher Schuko - cablu
 COD: EFFR-17029DE









 În conformitate cu CEI EN 60309-1-2

12,1 €

Adaptor stecher 400V cu priza Schuko 230V
 COD: EFFR-17025



 În conformitate cu CEI EN 60309-1-2

15,2 €

Stecher Schuko
 COD: EFFR-S316/DE

Montarea mânerului cu dispozitiv de fixare rapidă
 Cablu strâns cu inel anti-desuruburi
 Rezistență bună la temperaturi ridicate și scăzute
 Aparat de conectare rapidă fără șuruburi Wives



 În conformitate cu CEI EN 60309-1-2







1,9 €

Stecher
 COD: EFFR-S53267

Montarea mânerului cu dispozitiv de fixare rapidă
 Cablu strâns cu inel anti-desuruburi
 Rezistență bună la temperaturi ridicate și scăzute
 Aparat de conectare rapidă fără șuruburi Wives



 În conformitate cu CEI EN 60309-1-2







11,3 €

Stecher de perete cu inversiune de faze
 COD: EFFR-S53267P-INV

Montarea mânerului cu dispozitiv de fixare rapidă
 Cablu strâns cu inel anti-desuruburi
 Rezistență bună la temperaturi ridicate și scăzute
 Aparat de conectare rapidă fără șuruburi Wives



 În conformitate cu CEI EN 60309-1-2







26,6 €

Intreupator cu doua butoane stop
 COD: EFFR-SMM/I

Comutator pentru scule electrice incorporate.
 Conexiune prin faston.
 Functie oprire urgenta.
 Garnitura si suport de fixare.
 Cu contact de auto-prindere separat și cu punte pentru utilizarea unui tampon termic sau a unui buton de urgență extern.



 În conformitate cu CEI EN 60947





9,6 €

Intreupator cu autoretinere, doua butoane stop
 COD: EFFR-SMM/II/AU

Comutator pentru scule electrice incorporate.
 Conexiune prin faston.
 Functie oprire urgenta.
 Garnitura si suport de fixare.
 Cu contact de auto-prindere separat și cu punte pentru utilizarea unui tampon termic sau a unui buton de urgență extern.



 În conformitate cu CEI EN 60947





9,6 €

- Caseta ABS rosie
 - Cablu cauciuc H07RN-F
 - Lungime 3,5m sectiune 2.5mmq
 - Mufa de alimentare CEE, standard IEC 309
 - Suruburi interne, externe si arcuri din otel inoxidabil
 - Maner de transport
 - Posibilitate de montare pe trepid
 - Posibilitate de fixare pe perete cu console de fixare
- Pentru utilizarea continuă a comutatoarelor, „In”este retrogradat la un „I termic” mai mic de 35%.

IP
44

A
16



Tablou electric echipat cu 4 prize

COD: EFPO-DN0121

Caracteristici tehnice:

Putere max.: 8 kW
Alimentare (tip): mufa CEE 16A 3P + N + T IP44
1 x priza Schuko / 16A
2 x prize 2P + E 16A
1 x priza 3P + E 16A

192 €



Tablou electric echipat cu 4 prize

COD: EFPO-DN1111

Caracteristici tehnice:

Putere max.: 8 kW
Alimentare (tip): mufa CEE 16A 3P + N + T IP44
1 x priza Schuko / 16A
1 x priza 2P + E 16A
1 x priza 3P + E 16A
1 x priza 3P + N + E 16A

196 €



Tablou electric echipat cu 4 prize

COD: EFPO-DN0022

Caracteristici tehnice:

Putere max.: 8 kW
Alimentare (tip): mufa CEE 16A F + N + T IP44
2 x prize Schuko / 16A
2 x prize 2P + T 16A

168 €

Panou electric portabil, practic si usor de manevrat. Datorită versatilității, compactității și robusteții, poate fi utilizat în: șantiere, service-uri, agricultură, laboratoare precum și în zone unde este necesară rezistența mare la impact, la temperaturi sau substanțe chimice.

Caseta robustă și durabilă, realizată din ABS, cu garnitura de închidere integrată.

Mâner de transport construit împreună cu corpul de panoul și suruburile de închidere din oțel inoxidabil.

Protecție integrată magnetică/reziduală.

Poate fi montat pe un suport sau pe perete cu accesorii adecvate.



IP44



In conformitate cu CEI EN 61 439-4



COD: EFPS-DS101010020/35SP
COD: EFPS-DS101011020/35SP
Tablourile includ cablu 3,5 m



COD: EFPO-DE001010012G



COD: EFPS-DE101010014GP



3P+N+T
63 A



3P+N+T
32 A



3P+N+T
16 A



3P+T
16 A



2P+T
16 A



2P+T
16 A



Buton
oprire
urgenta



Putere max.
(Kw)



Tip priză

	3P+N+T 63 A	3P+N+T 32 A	3P+N+T 16 A	3P+T 16 A	2P+T 16 A	2P+T 16 A	Buton oprire urgenta	Putere max. (Kw)	Tip priză	
Tablou electric IP66 echipat cu prize	1	1	1	0	2	0	DA	35	3P+N+T 63A	643 €
COD: EFPS-DS101010020/35SP										
Tablou electric IP66 echipat cu prize	1	1	1	1	2	0	DA	35	3P+N+T 63A	654 €
COD: EFPS-DS101011020/35SP										
Tablou electric IP44 echipat cu prize	0	1	1	0	1	2	DA	18	4P+T 32A	220 €
COD: EFPO-DE001010012G										
Tablou electric IP44 echipat cu prize	1	1	1	0	1	4	DA	35	4P+T 63A	520 €
COD: EFPS-DE101010014GP										

ECHIPAMENTE PENTRU TAIERE GRESIE | FAIANTA

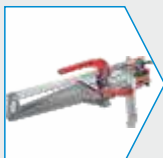

Masini manuale de taiat gresie | faianta
Pagina 111



Masini electrice de taiat gresie | faianta
Pagina 113



Echipamente diverse pentru taiere/finisare si ventuze ridicare
Pagina 114



Freze, caroate si accesorii
Pagina 115



Discuri diamantate
Pagina 116



Cod produs

Descriere produs

Pret Euro (fara TVA)

MiniMontolit Masina de taiat gresie si faianta, gama economica

8023743000245	MiniMontolit 24 Dimensiuni de taiere 220mm, adancime 15mm	40,5
8023743007015	MiniMontolit 26A2 Dimensiuni de taiere 360mm, adancime 20mm	81,9
8023743007022	MiniMontolit 43A2 Dimensiuni de taiere 450mm, adancime 20mm	115



MiniPiuma Masina de taiat gresie si faianta, gama profesionala

8023743004083	MiniPiuma 26P Dimensiuni de taiere 360mm, adancime 20mm	150
8023743004120	MiniPiuma 26PB Dimensiuni de taiere 360, adancime 20mm, include geanta plastic	180
8023743004106	MiniPiuma 43P Dimensiuni de taiere 450mm, adancime 20mm	178
8023743004137	MiniPiuma 43PB Dimensiuni de taiere 450, adancime 20mm include geanta plastic	208



MasterPiuma Masina de taiat gresie si faianta, gama profesionala cu sistem de lubrifiere automat a rotitei de taiere

8023743018059	MasterPiuma 44P3 Dimensiuni de taiere 440mm, adancime 22mm	245
8023743018066	MasterPiuma 52P3 Dimensiuni de taiere 520mm, adancime 22mm	264
8023743018073	MasterPiuma 63P3 Dimensiuni de taiere 630mm, adancime 22mm	293
8023743018080	MasterPiuma 75P3 Dimensiuni de taiere 750mm, adancime 22mm	348
8023743018097	MasterPiuma 93P3 Dimensiuni de taiere 930mm, adancime 22mm	393
8023743018103	MasterPiuma 125P3 Dimensiuni de taiere 1.250mm, adancime 22mm	650
8023743018110	MasterPiuma 155P3 Dimensiuni de taiere 1.550mm, adancime 22mm	831



Art. 63P5
63cm



Art. 75P5
75cm



Art. 93P5
93cm



Art. 131P5
131cm



Art. 161P5
161cm

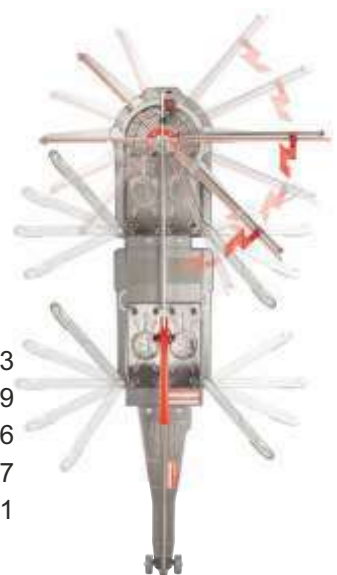

8023743030198	MasterPiuma 63P5-XL Dimensiuni de taiere 630mm, adancime 20mm	323
8023743028584	MasterPiuma 75P5 Dimensiuni de taiere 750mm, adancime 20mm	379
8023743028591	MasterPiuma 93P5 Dimensiuni de taiere 930mm, adancime 20mm	426
8023743028607	MasterPiuma 131P5 Dimensiuni de taiere 1.310mm, adancime 20mm	657
8023743028614	MasterPiuma 161P5 Dimensiuni de taiere 1.610mm, adancime 20mm	841

Cod produs

Descriere produs

Pret Euro (fara TVA)

8023743030303 **ATLAS - Suport reglabil pentru placi ceramice mari.** 74,3



Înălțime reglabilă: se poate adapta fără probleme la aproape orice masina de taiat gresie/faianta de pe piață.

Sistem cu arcuri: Acest sistem permite placii de gresie/faianta să coboare ușor în timpul inciziei.

Baza anti-alunecare: Suprafața antialunecare face ca ATLAS sa rămână ferm pe poziție în timpul utilizării.

Proudly Italian: 100% proiectat și fabricat în Italia, garantând o calitate de top.

Ecologic: Fabricat din plastic ABS reciclabil, ATLAS nu este doar extrem de durabil, ci și responsabil cu mediul înconjurător.



Set 2 buc.



8023743018141 245T Rotita TITAN pentru seriile MINI si MASTER

7,6

8023743006902 Protectie cauciuc pentru taiere mozaic

41,3



8023743017717 Baseboard art.64 Suport pentru directionare placa, pentru seria MASTER

47,2



8023743018202 515-5 Fiola ulei de lubrifiere (set 5 buc.)

7,6

8023743019193 Vertigo Suport pentru taiere verticala, pentru seria MASTER

315



8023743020724 Cover - Husa pentru masinile de taiat Masterpiuma

41,3



8023743017939 Maner 7mm compatibil cu seria P2 - P3 (44 - 63P3)

65

8023743017946 Maner 12mm compatibil cu seria P2 - P3 (75 - 155P3)

69,2



Accesoriu pentru ruperea placii dupa taiere

8023743013733 449P Sistem de rupere a placii, se utilizeaza impreuna cu art. 507 sau 446P

27,8

8023743018264 Accesoriu rupere placa seria P3

16,9

8023743006063 Accesoriu rupere placa pentru seria P2

13,5



Cod produs	Descriere produs	Pret Euro (fara TVA)
------------	------------------	----------------------

8023743020397	F1-131 Masina pentru taiat gresie, faianta, motor 2,2 kW Lungime max. 1.310 mm, grosime 0- 50 mm Disc Ø250 mm inclus, coroana sectionata, taiere la 90° si 45° Greutate echipament: 85 kg	2.415
---------------	---	-------



8023743020403	F1-151 Masina pentru taiat gresie, faianta, motor 2,2 kW Lungime max. 1.510 mm, grosime 0 - 50 mm Disc Ø250 mm inclus, coroana sectionata, taiere la 90° si 45° Greutate echipament: 100 kg	2.872
---------------	---	-------



8023743020410	F1-181 Masina pentru taiat gresie, faianta, motor 2,2 kW Lungime max. 1.810 mm, grosime 0 - 50 mm Disc Ø250 mm inclus, coroana sectionata, taiere la 90° si 45° Greutate echipament: 112 kg	3.458
---------------	---	-------

8023743023343	Top Profile echipament pentru slefuirea marginilor placilor de gresie/faianta fara praf, motor 230V, 800 W, turatie 11.000 rpm, Greutate 4,7 kg	562
---------------	--	-----

8023743023374	FPE15TP Disc diamantat R 15 mm, unghi 45°, mediu	149
---------------	---	-----

8023743023381	FPE15TPGF Disc diamantat R 15 mm, unghi 45°, fin	149
---------------	---	-----

BMFPE03TP	FPE03TP Disc diamantat R 3 mm, unghi 45°	113
-----------	---	-----

BMFPE05TP	FPE05TP Disc diamantat R 5 mm, unghi 45°	123
-----------	---	-----

8023743023411	FPB03TP Disc diamantat R 3 mm	115
---------------	--------------------------------------	-----

8023743023428	FPB05TP Disc diamantat R 5 mm	123
---------------	--------------------------------------	-----

8023743023435	FPB10TP Disc diamantat R 10 mm	141
---------------	---------------------------------------	-----

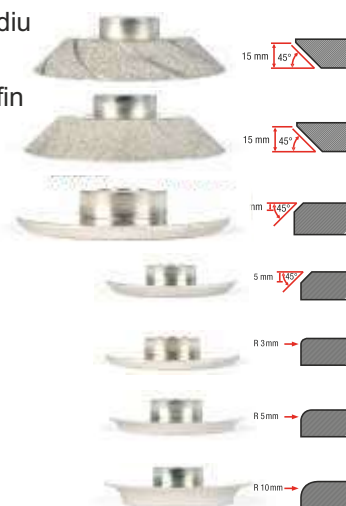

8023743027891	Flash Line EVO3 - Echipament pentru taierea placilor extra mari	464
---------------	--	-----

Lungime max. 3.400 mm
Grosime placa 0 - 10 mm
Greutate: 8 kg
Echipare standard: 3 segmente x 1.200 mm cu banda silicon anti alunecare + dispozitiv taiere + dispozitiv rupere + husa transport



8023743021301	Moto Flash Line - Echipament pentru taierea placilor extra mari	844
---------------	--	-----

Motor electric 1,6 kW, 230V, turatie 5.000 rpm
Lungime max. taiere 3.400 mm; Grosime placa 0- 200 mm
Disc inclus: TCS150MFL 150 mm, prindere disc 30 / 22,5 mm
Echipare standard: 3 segmente x 1.200 mm cu banda silicon anti alunecare + dispozitiv taiere + dispozitiv rupere + husa transport
Greutate: 12,8 kg



8023743000566	Art. 54 Cleste pentru ceramica Montolit 54	25,3
---------------	---	------

8023743022339	Art. 33W Cleste pentru ceramica Montolit 33W	43,1
---------------	---	------

8023743023015	Art. 55W2 Cleste pentru ceramica Montolit 55W cu role 242TW	35,4
---------------	--	------

8023743001839	Art. 25V Cutter pentru taiere sticla/ceramica/vitrocaramica Montolit	24,5
---------------	---	------

Cod produs	Descriere produs	Pret Euro (fara TVA)
8023743021332	300-76 Ventuza pentru ridicare placi de mari dimensiuni Sarcina max.150 kg, diam. exterior 200mm.	160
8023743023060	Battile Ventuza electrica cu vibratii pentru ridicat placi de mari dimensiuni Motor 8,4V, acumulator Li-ion 2,5 Ah 21 Wh Amperaj incarcare 1,5A, timp de reincarcare 2 h Frecventa vibratii 5.000 - 18.000 rpm, greutate 0,95 kg	177
8023743028072	Battile Pro-2B Ventuza electrica cu vibratii, ridicare placi de mari dimensiuni Motor 16V, 2 acumulatori Li-ion 2 Ah 32 Wh Amperaj incarcare 1 A, timp de reincarcare 2,5 h Frecventa vibratii 5.000 - 12.000 rpm, greutate 1,35 kg	295
8023743030426	Gecone - Ventuza electrica cu acumulator Li-Ion 12V 1.5Ah, sarcina max. 200kg, concepută EXCLUSIV pentru ridicarea plăcilor ceramice și porțelanului, sticlei, granitului și marmurei, indiferent de grosime. Nou! GECONE vine standard cu trei inele de etanșare interschimbabile pentru suprafețe netede, texturate și 3D. Suprafata contact 300x600mm, Greutate: 1,6 kg	305
8023743030211	GECO E-POWER - Ventuza electrica cu acumulator, sarcina maxima 100 kg	220
8023743029055	GECO - Ventuza manuala, sarcina maxima 125 kg	109
BM300-80L	Lift 300-80L capacitate ridicare 40 kg, greutate sistem 9,5 kg	533
8023743024128	Super Lift 300-70SL-MOB , capacitate ridicare 80 kg, Greutate sistem 34 kg	1.205
BMSUPERLIFTEP	Sistem complet Superlift ePOWER pentru ridicare/montare placi ceramice. Structură din oțel nichelat și aluminiu, sarcina max 400 kg (100kg / ventuza), greutate 26 kg, ventuze profesionale cu baterie.	1.564
8023743017120	300-20 Masa de lucru pentru placi foarte mari Barele de aluminiu au insertii de cauciuc anti-alunecare Dimensiuni 1.150 x 1.800 mm, greutate 34 kg	670
8023743023497	Blockut - Ghilotina pentru pavele, dale si borduri gama profesionala, forta de rupere 4.100 kg Blockut - Ghilotina Montolit lungime taiere 330 mm, grosime 0 - 110 mm Presiune max. aplicata 4.100 kg, greutate echipament 28 kg	472
8023743000450	Art. 42 Ghilotina pentru tigle	238
8023743023503	Art. 208BC Set lame ghilotina Blockut	16
BM0003419	Art. 205 Set lame ghilotina Revolver 4	120
BM0003244	Art. 208L Set lame ghilotina Revolver 6L	89
8023743017335	PINZONE Manere pentru borduri/pavele din piatra, granit sau ciment Nou! Grosime material intre 5-18 cm Sarcina max.: 200 kg, Greutate echipament: 11 kg	257

Cod produs Descriere produs Pret Euro (fara TVA)

Perforari in: gresie portelanata, ceramica, faianta, granit, marmura, mozaic



- 8023743015317 **FAJ05** Freza pentru ceramica diam. 5mm Montolit
- 8023743015324 **FAJ06** Freza pentru ceramica diam. 6mm Montolit
- 8023743015331 **FAJ08** Freza pentru ceramica diam. 8mm Montolit
- 8023743015348 **FAJ10** Freza pentru ceramica diam. 10mm Montolit
- 8023743015355 **FAJ12** Freza pentru ceramica diam. 12mm Montolit
- 8023743000849 Suport cu prindere in mandrina pentru freza diamantata Montolit



- 21,9
- 19,5
- 20,5
- 20,5
- 25,0
- 58,2



Perforari in: gresie portelanata, ceramica, faianta, granit



- BM0003874 **FTJ05** Freza diamantata pentru ceramica diam. 5mm Montolit
- BM0003875 **FTJ06** Freza diamantata pentru ceramica diam. 6mm Montolit
- BM0003876 **FTJ08** Freza diamantata pentru ceramica diam. 8mm Montolit
- BM0003877 **FTJ10** Freza diamantata pentru ceramica diam. 10mm Montolit
- BM0003878 **FTJ12** Freza diamantata pentru ceramica diam. 12mm Montolit



- 35,2
- 38,0
- 38,3
- 40,6
- 53,1



Perforari in: gresie portelanata, ceramica dura, granit, marmura

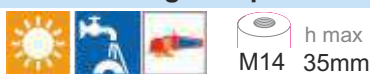

- 8023743013290 **FS16** Carota ceramica/granit/marmura diam. 16mm Montolit
- 8023743003086 **FS20** Carota ceramica/granit/marmura diam. 20mm Montolit
- 8023743013313 **FS30** Carota ceramica/granit/marmura diam. 30mm Montolit
- 8023743006483 **FS40** Carota ceramica/granit/marmura diam. 40mm Montolit
- 8023743000801 **FS50** Carota ceramica/granit/marmura diam. 50mm Montolit
- 8023743013504 **FS68** Carota ceramica/granit/marmura diam. 68mm Montolit
- 8023743019629 Art. AUFS Adaptor pentru conectare cu masina de gaurit



- 51
- 61
- 73,4
- 90
- 114
- 134,4
- 16,03



Perforari in: gresie portelanata, ceramica, faianta, granit, marmura



- BM0003885 **FA20** Carota-umed ceramica/granit/marmura diam. 20mm Montolit
- BM0003886 **FA30** Carota-umed ceramica/granit/marmura diam. 30mm Montolit
- BM0003887 **FA35** Carota-umed ceramica/granit/marmura diam. 35mm Montolit
- BM0003888 **FA40** Carota-umed ceramica/granit/marmura diam. 40mm Montolit
- BM0003889 **FA50** Carota-umed ceramica/granit/marmura diam. 50mm Montolit
- BM0003890 **FA60** Carota-umed ceramica/granit/marmura diam. 60mm Montolit
- BM0003891 **FA70** Carota-umed ceramica/granit/marmura diam. 70mm Montolit
- BM0003892 **FA75** Carota-umed ceramica/granit/marmura diam. 75mm Montolit
- 8023743008289 **FA100** Carota-umed ceramica/granit/marmura diam. 100mm Montolit
- 8023743021257 Art. AUFA Adaptor pentru conectarea cu masina de gaurit



- 66,4
- 68,8
- 70,3
- 73,4
- 80
- 97
- 105
- 110
- 141
- 16



- 8023743019780 **M-Performer** Pasta pentru racirea frezelor, creste durata de viata a frezei si viteza de lucru

13,5

Cod produs	Descriere produs	Pret Euro (fara TVA)	
Disc taiere gresie portelanata, ceramica Pro, granit			
8023743011975	SCX200 Disc 200 mm, grosime 2 mm, prindere 25,4 / 22,2 mm	114	
8023743011982	SCX250 Disc 250 mm, grosime 2,2 mm, prindere 30 / 25,4 mm	150	
8023743012149	SCX300 Disc 300 mm, grosime 2,4 mm, prindere 30 / 25,4 mm	171	
8023743020687	SCX350 Disc 350 mm, grosime 2,4 mm, prindere 30 / 25,4 mm	223	
8023743020687	SCX400 Disc 400 mm, grosime 3,2 mm, prindere 60 / 50 mm		
Disc SCXS-T coroana continua pentru gresie portelanata, ultragroase, ceramica si granit			
8023743021394	SCXS-T 200 Ø 200 mm, grosime 2 mm, prindere 30/25,4 mm	141	
8023743021400	SCXS-T 250 Ø 250 mm, grosime 2,2 mm, prindere 30/25,4 mm	178	
8023743021417	SCXS-T 300 Ø 300 mm, grosime 2,4 mm, prindere 30/25,4 mm	200	
8023743021424	SCXS-T 350 Ø 350 mm, grosime 2,4 mm, prindere 30/25,4 mm	259	
Disc CGX pentru gresie portelanata/ceramica dura			
8023743021455	CGX115 Ø115 mm, grosime 1,3 mm, prindere 22,2 mm	45,2	
8023743021462	CGX125 Ø 125 mm, grosime 1,3 mm, prindere 22,2 mm	50,0	
Disc CX coroana continua, pentru gresie portelanata, ceramica delicata, marmura si granit			
8023743020328	CX 250 Ø 250 mm, grosime 2 mm, prindere 30/25,4 mm	118	
8023743020335	CX 300 Ø 300 mm, grosime 2,2 mm, prindere 30/25,4 mm	137	
8023743020342	CX 350 Ø 350 mm, grosime 2,2 mm, prindere 30/25,4 mm	180	
Disc taiere gresie portelanata, ceramica dura			
8023743014877	CG115 Ø 115 mm, 22,2 mm	43	
8023743014884	CG125 Ø 22,2 mm	47	
Disc taiere mozaic, piatra naturala, ceramica fina si moale			
8023743006506	CM100 Disc 100 mm, grosime 1,2 mm, prindere 22,2 mm	37,5	
8023743006513	CM115 Disc 115 mm, grosime 1,2 mm, prindere 22,2 mm	40,5	
8023743006520	CM125 Disc 125 mm, grosime 1,2 mm, prindere 22,2 mm	42	
Disc taiere gresie portelanata, ceramica dura			
8023743015263	TCS85 Disc Red Line 85 mm, grosime 1 mm, prindere 22,2 mm	26,6	
Disc Perfetto coroana sectionata pentru gresie portelanata, ceramica delicata, vetro, marmura si granit			
BM2008306	CPF180 Ø 180 mm, grosime 2 mm, prindere 30/25,4 mm	69,5	
BMC PF200	CPF220 Ø 200 mm, grosime 2 mm, prindere 30/25,4 mm	78,9	
8023743009507	CPF250 Ø 250 mm, grosime 2 mm, prindere 30/25,4 mm	115	
8023743009521	CPF350 Ø 350 mm, grosime 2,2 mm, prindere 30/25,4 mm	177	
Disc Slim Cut diamantat pentru plăci subțiri			
BMCS150	CSS150 Ø 150 mm, grosime 22.2 mm, prindere 1,3 mm	91	

Cod produs	Descriere produs	Pret Euro (fara TVA)	
Disc XAMURAY CPH pentru ceramica/gresie portelanata/marmur/granit			
8023743018936	CPH180 Ø 180 mm, grosime 1,6 mm, prindere 25,4/22,2 mm	58,9	
8023743018929	CPH200 Ø 200 mm, grosime 1,6 mm, prindere 30/25,4 mm	69,4	
8023743018981	CPH230 Ø 230 mm, grosime 1,6 mm, prindere 30/25,4 mm	102	
8023743018998	CPH250 Ø 250 mm, grosime 1,65 mm, prindere 30/25,4 mm	106	
8023743019001	CPH300 Ø 300 mm, grosime 2,0 mm, prindere 30/25,4 mm	129	
8023743019018	CPH350 Ø 350 mm, grosime 2,2 mm, prindere 30/25,4 mm	167	
Disc TBH pentru taiere beton/granit/gresie portelanata			
8023743007114	TBH180 Ø 180 mm, grosime 2,4 mm, prindere 22,2 mm	59,7	
8023743007121	TBH200 Ø 200 mm, grosime 2,4 mm, prindere 30/25,4 mm	63,7	
BMTBH150	TBH150 Ø 200 mm, grosime 2,4 mm, prindere 30/22,2 mm	68,0	
8023743007138	TBH230P Ø 230 mm, grosime 2,4 mm, prindere 22,2 mm	77,4	
Disc LEH universal pentru materiale de constructii si piatra			
8023743012842	LEH230P Ø 230 mm, grosime 2,4 mm, prindere 22,2 mm	61,3	
8023743012859	LEH30018 Ø 300 mm, grosime 2,8 mm, prindere 30/25,4 mm	112	
8023743012866	LEH35021 Ø 350 mm, grosime 3,2 mm, prindere 30/25,4 mm	139	
Disc LBH diamantat - taiere uscata - pentru beton, granit, piatra dura			
8023743012026	LBH160 Ø 160 mm, grosime 2,4 mm, prindere 22,2 mm	82,3	
8023743003994	LBH180 Ø 180 mm, grosime 2,4 mm, prindere 22,2 mm	78,2	
8023743004038	LBH250 Ø 250 mm, grosime 2,4 mm, prindere 30/25,4 mm	105	
8023743004052	LBH350 Ø 350 mm, grosime 2,4 mm, prindere 30/25,4 mm	171	
Nou!	Disc SSD pentru gresie portelanata		
8023743028454	SSD115 Ø 115 mm, prindere 22,2 mm	36,3	
8023743028461	SSD125 Ø 125 mm, prindere 22,2 mm	39,5	
Nou!	Disc CZ pentru gresie portelanata si ceramica		
8023743018400	CZ100 Ø 100 mm, grosime 1,4 mm, prindere 22,2/15,8	17,8	
8023743003765	CZ115 Ø 115 mm, grosime 1,4 mm, prindere 22,2 mm	19,4	
8023743003772	CZ125 Ø 125 mm, grosime 1,4 mm, prindere 22,2 mm	21,0	
8023743003789	CZ180 Ø 180 mm, grosime 1,6 mm, prindere 22,2 mm	48,0	
Nou!	Disc TCS-E pentru gresie portelanata si ceramica		
8023743018356	TCS100E Ø 100mm, grosime 1,4 mm, prindere 22,2/15,8 mm	21,0	
8023743006742	TCS115E Ø 115 mm, grosime 1,4 mm, prindere 22,2 mm	21,8	
8023743019124	TCS125E Ø 125 mm, grosime 1,4 mm, grosime 1,4 mm	22,6	
Nou!	Disc TZ pentru pentru materiale de constructii		
8023743001976	TZ115 Ø 115 mm, prindere 22,2 mm, grosime 2,0 mm	20,2	
8023743002065	TZ230P Ø 230 mm, prindere 22,2 mm, grosime 2,6 mm	41,1	
Nou!	Disc TCS-R pentru gresie portelanata si ceramica dura		
8023743018028	TCS100R Ø 100 mm, prindere 22,2 / 15,8 mm, grosime 1,4 mm	36,7	
8023743006568	TCS115R Ø 100 mm, prindere 22,2 mm, grosime 1,4 mm	37,5	
8023743011883	TCS125R Ø 100 mm, prindere 22,2 mm, grosime 1,4 mm	40	
8023743017045	TCS250R Ø 250 mm, prindere 3 / 25,4 mm, grosime 1,65 mm	117	
8023743025484	SAFE DIAMOND BOX Cutie accesorii diamantate Lxlxh 300x130x350 mm	47,3	

Cod produs

Descriere produs

Pret Euro (fara TVA)

Perforari in: gresie portelanata, ceramica, granit, marmura, mozaic

BMFPUS6 **FPUS6** Freza speciala pentru modelari speciale, 6 mm



58

8023743020267 **FPU20** Freza speciala pentru modelari speciale, 20 mm



84,4

Perforari in: gresie portelanata, ceramica, granit, marmura, mozaic

BMFPS35 **FPS35** Freza speciala pentru modelaj conica, 5 - 35 mm

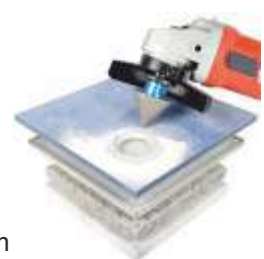

97,7



8023743021981 **FPS75** Freza speciala pentru modelaj conica, 35 - 75 mm



180

8023743022247 **FPUB20** Freza pentru largire gauri/modificare forma, ceramica Ø20 mm

84,4



Disc finisare gresie pentru rotunjire margini

BM0003894 Disc **FPB10** M14 pentru finisare gresie/rotunjire margini, 10 mm

184



BMAFTERCUT **AFTERCUT** pentru netezirea marginilor ciobite la plăci ceramice și porțelan

148



BMFP-GO **FP-GO** Freza diamantata pentru canale picuratoare - pentru trepte/scari

178



BMFP-AS **FP-AS** Freza diamantata pentru canale anti-alunecare - pentru trepte/scari

356



8023743011104 **DT200** Slefuitor manual finisare extra fin margine gresie, gr.200

20,5

8023743011098 **DT060** Slefuitor manual finisare medie margine gresie, gr.60

27,5

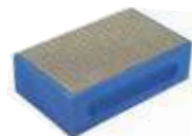

8023743030457 Piatra pentru curatare discuri si freze diamantate 206x73x30 mm

48



Piatra este realizată cu două granulații:

Granulație medie (partea albastră) pentru discurile pentru beton și granit, utilizate în general uscate.

Granulație fină (partea albă) pentru discurile și tăietoarelor pentru ceramică și marmură, utilizate în general umede.

Cod produs

Descriere produs

Pret Euro (fara TVA)

Disc taiere / polizare gresie portelanata, granit, piatra, beton

8023743020281 **STL125GG** Disc 125 mm prindere 22,2 mm

8023743024036 **STL125GG-M** Disc 125 mm prindere 22,2 mm



100

106



Discuri lamelare diamantate

8023743026092 **FLEXIMONTGF** granulatie fina, Ø 115 mm, prindere 22,2 mm

8023743026115 **FLEXIMONTGG** granulatie grosiera, Ø 115 mm, prindere 22,2 mm

8023743026108 **FLEXIMONTGM** granulatie medie, Ø 115 mm, prindere 22,2 mm



58,1

60,5

59,1



Nou!



8023743031874 **CJ115** gresie portelanata/granit/piatra naturala, teracota Ø 115 mm M22.2

BMCJ125 **CJ125** gresie portelanata/granit/piatra naturala, teracota Ø 125 mm M22.2

Nou!



62

69



TRITONE - Disc de șlefuit diamantat pentru lustruire, potrivit atât pentru

utilizarea uscată cât și umedă, cu polizoare unghiulare.

Ideal pentru netezire beton, marmură, granit, piatră, plăci de porțelan și pentru îndepărtarea adezivului și a epoxidului.



8023743029406 **TRITONE125**, Ø 125 mm, prindere 22,2 mm

Nou!



124

BM300-VAS Kit accesorii diamantate Montolit

556

Nou!

Kit-ul contine:

Cutie + Disc TCS85 + Disc CGX115 + FAJ06/08 + FSS27/35/50 + DT060 + DT200



REPREZENTANȚI VÂNZĂRI DISTRIBUȚIE

Zona Nord-Vest

Adrian Șerban
0759.032.235
adrian.serban@italiastar.ro

Zona Nord-Est

Robert Amolioaiei
0743.616.118
robert.a@italiastar.ro

Zona Vest

Bogdan Rusan
0759.207.471
bogdan.rusan@italiastar.ro

Zona Sud-Vest

Catalin Mușat
0756.180.620
catalin.musat@italiastar.ro

Zona Sud-Est

Paul Istrate
0744.340.500
paul.istrate@italiastar.ro

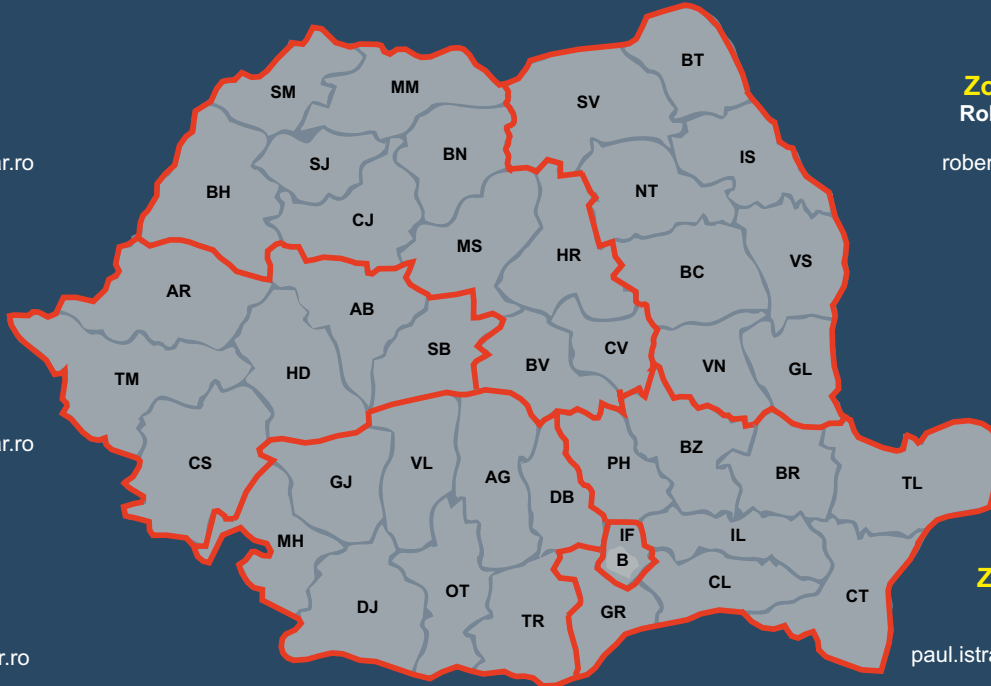

Director Național Vânzări

Gabi Stanciu
0720.660.774
gabi.stanciu@italiastar.ro

Director Suport Vânzări

Mihaela Toma
0723.274.885
mihaela.toma@italiastar.ro

ASISTENȚĂ TEHNICĂ

ASISTENȚĂ TEHNICĂ SISTEME DE POMPARE

Daniel Cojocaru
0755.090.529
servicetm@italiastar.ro

SERVICE MICA MECANIZARE

Marius Lazăr
0758.644.374
service@italiastar.ro

SERVICE AGRO GARDEN

Razvan Morlova
0755.090.519
razvan.morlova@italiastar.ro

ASISTENȚĂ TEHNICĂ / MENTENANTA

Cosmin Marinescu
0745.024.593
cosmin.marinescu@italiastar.ro

COMENZI / INFO STOC

SUPORT VÂNZĂRI

Alexandru Stoica
0749.281.448

Cristina Floarea
info@italiastar.ro

DEPOZITE EXTERNALIZATE

HOPI RO LOGISTICS S.R.L.

Adresa:
Str. Italia nr. 1-7, Chiajna, Ilfov, depozit 10
Nr. tel Team Leader: 0758053979

SLS Cargo

Adresa:
1-7 No. Italia Street, Warehouse 0, Chiajna City, Ilfov
Nr. tel Team Leader: 0738719169

ITALIA STAR ACADEMY

CENTRUL DE TRAINING ȘI FORMARE PROFESIONALĂ

Adresa:
Autostrada București-Pitești Km. 13,2
Chiajna, jud. Ilfov

Pentru informații, vă rugăm să
contactați reprezentantul dvs. zonal

SEDIU / DEPOZIT / SERVICE

Adresa:
Autostrada București - Pitești km 13,2,
Chiajna, Jud. Ilfov - România C.P. 077040
Coordonate GPS: 44.438989, 25.943253

Telefon: 021.433.03.27
0756.169.788
e-mail: info@italiastar.ro
www.italiastar.ro



**Intrarea in vigoare a prezentei liste,
duce la anularea tuturor versiunilor anterioare.**

Informații cu caracter confidențial
Copierea sau distribuirea acestui catalog este strict interzisă fără acordul scris din partea Italia Star.
Fotografiile, specificatiile tehnice și prețurile expuse în acest catalog nu reprezintă obligație contractuală
și pot suferi modificări fără notificare în prealabil a clienților.

